

# The perfect connection.

The DOMINO system user manual.



**FESTOOL**

Tools for the toughest demands



---

# The perfect connection.

The DOMINO system user manual.

---

Two men. One conversation. And the origin of a brilliant idea:  
the DOMINO connecting system.

There are numerous draft designs, CAD drawings, parts lists and documentation for our DOMINO connecting system. Yet the conversation and initial drawings where the idea was formed was on something a lot less imaginative: a napkin.

But first things first. To be precise, it was initially only an informal exchange between two practitioners in our canteen, pondering what the optimal domino should be capable of.

And because nothing else was readily available, they sketched a domino on a napkin to represent the demand for 'more stability'. Then a second sketch next to it for a 'larger glue surface'. And finally a third for absolute 'rotation resistance' at the first attempt. Using the simple equation: make one from three, the foundation was laid for the DOMINO DF 500 domino system.

What was missing was the fitting hole – and thus the real challenge began. That is to say, the development of a completely new tool. With the typical southern German inventiveness, infinite passion and the concentrated expertise of our engineers, a mix of traditional vertical bore and simultaneous horizontal routing movement was created – the birth of the DOMINO pendulum router principle as the driving force for the new DOMINO DF 500.

From its origins on a simple napkin, to a design that has not only revolutionised the traditional timber joint, but has been continuously developed since then with further options: the DOMINO XL DF 700 and the newly developed corner and flat connectors, forming a complete DOMINO connecting system. For what has always been extremely stable, is now also flexible, with separable rack, board and frame joints.

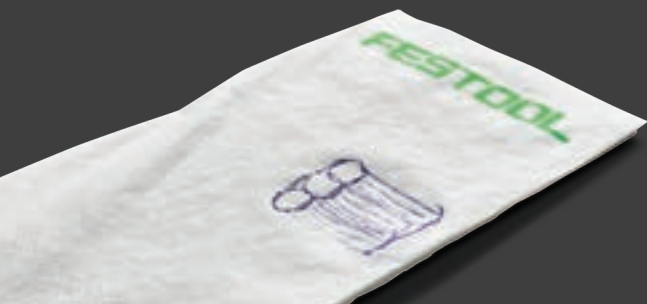



---

# Contents

	PAGE
<b>1 DOMINO joining machine fundamentals</b>	<b>11</b>
1.1 The DOMINO pendulum router principle	12
1.2 The domino slot principle	13
1.3 The DOMINO joining machines: an overview	14
1.4 Performing basic settings for the DOMINO joining machines	16
Switching on/off	16
Selecting hole width	17
Selecting domino length and thickness	17
Cutter replacement	18
Depth adjustment range	19
Height adjustment range	21
Angle adjustment range	23
Working with the stop system	24
Working with extraction	28
<b>2 The domino</b>	<b>31</b>
<b>3 DOMINO system accessories</b>	<b>37</b>
<b>4 Practical application examples</b>	<b>41</b>
4.1 Overview: making joints with the DOMINO joining machine	42
4.2 Frame joints	44
Mitred frame joints	44
Butted frame joints	46
Stable frame joints with the DOMINO DF 700	48
4.3 Rack joints and safe positioning of strips	50
4.4 Round profile joints	56
4.5 Stable, separable corner joints	58
4.6 Stable, separable flat joints	66
4.7 Mitred joints	74
4.8 Drawer joints	76
4.9 Butted board joints	79

---

<b>5</b>	<b>Items included, specifications</b>	<b>85</b>
<b>6</b>	<b>Accessories</b>	<b>87</b>
6.1	Cutters	88
6.2	Stops	89
6.3	Domino and connector	90
	Domino and domino rod- Beech	92
	Domino exterior use- Sipo	94
	Domino corner and flat connector	95
<b>7</b>	<b>Supplementary system accessories</b>	<b>97</b>
7.1	Mobile dust extractors	98
7.2	MFT 3 multifunction table	99
	MFT 3 accessories	99
7.3	VAC SYS vacuum pump and clamping unit	100
	VAC SYS accessories	100

---

## The DOMINO joint. Simply perfect.

**Every timber joint has its advantages. The DOMINO connecting system unites them all.** In truth, there are numerous innovations which were developed on the basis of a spontaneous idea. Such as the DOMINO connecting system. And yet it is also based just as much on the principle of thinking ahead. Thinking ahead in terms of a timber joint that unifies the benefits of all previously existing systems: the controversial stability of mortise and tenon, the flexibility of biscuits used in furniture making and the precision of the round dowel used in frame and rack making. We found the key for this in the patented pendulum routing movement and the resulting slots for accepting the specially formed dominos. For a new, complete timber connecting system, which assures with the highest possible stability. A connecting system that works simply and with considerably shorter set-up times and which can be used even for tasks that were previously predominantly the domain of stationary machines. To date we have not only convinced many tradespeople, but have been able to fill these people with enthusiasm about an idea that took a significant step further. For timber joints as unique as the DOMINO connecting system itself.





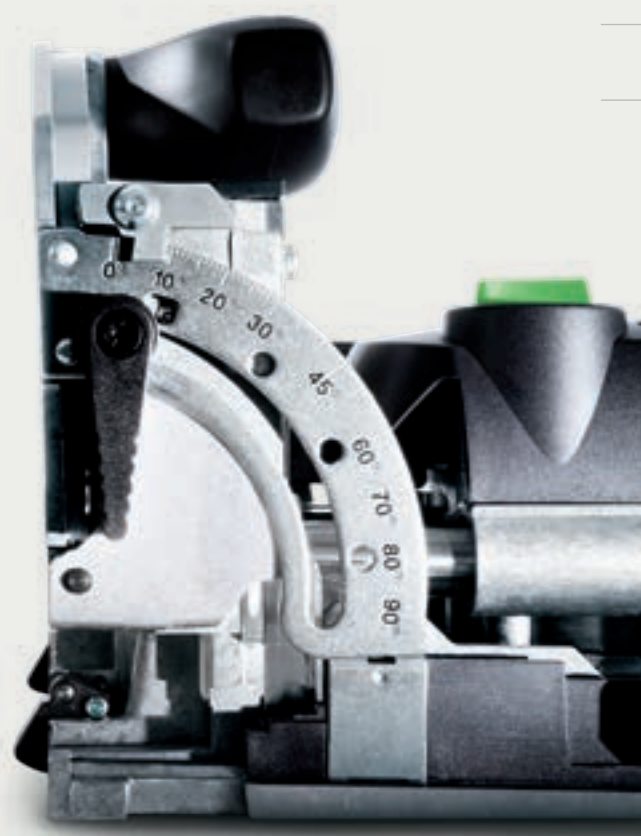

The DOMINO principle: Fast. Easy. Versatile.

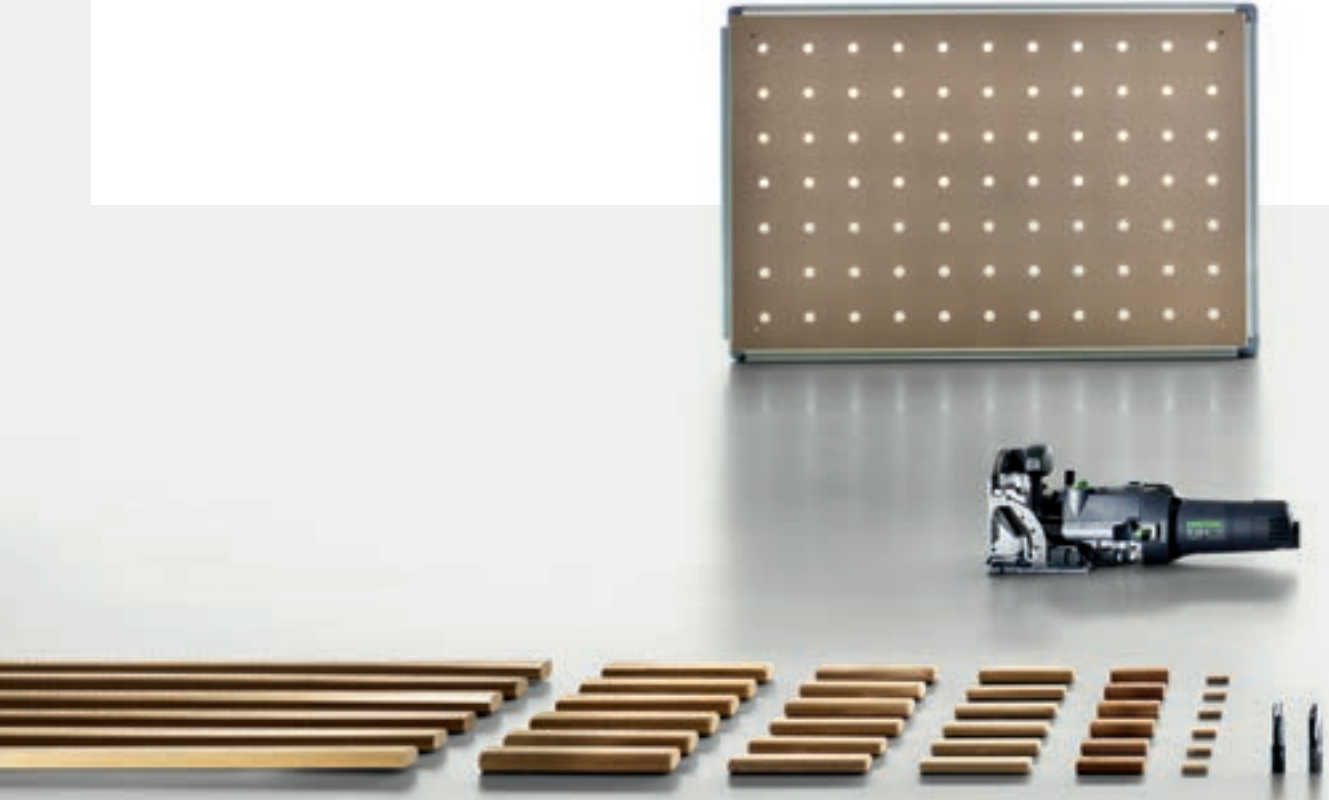

**Whether it is a small drawer or a large, solid timber door – DOMINO is the solution.** With the DOMINO connecting system all the benefits of round dowels and biscuits have been united into one for the first time. Just as quickly and effortlessly. For board, frame and rack joints. For narrow or wide, delicate or solid workpieces. With domino sizes from 4 mm to 14 mm diameter or flexible corner and flat connectors for infinite connection options. And with maximum time-saving without complex adjustments and measuring.





---

# DOMINO joining machine fundamentals

1



**Two routers – one principle.** The DOMINO joining machine is available in two sizes: the DF 500 for domino sizes of 4 x 20 mm to 10 x 50 mm, perfectly suited for board and furniture making, as well as for lightweight frame or rack joints. Or the DOMINO XL DF 700, allowing the use of domino sizes up to 14 x 140 mm. This means that the DOMINO XL is ideally suited for solid timber furniture and door construction and manufacturing stable solid timber connections.

## 1.1 The DOMINO pendulum router principle

Unique in its manual operation and patent by Festool: the DOMINO joining machine routing movement. The simultaneous rotating and pendulum movement of the cutter allows smooth working and holes without scorch marks. Thanks to the pendulum movement the cutters do not overheat, leading to an extremely high service life.



## 1.2 The domino slot principle

The first domino is positioned via an exact slot, the subsequent dominos inserted in wider slots with clearance – this allows the joint to be easily aligned. The result is a stable joint, rotation-resistant from the first domino.



### **Fits exactly.**

The slot is precisely routed using the stop catches (DF 500) or stop pins (DF 700). The workpiece is aligned to the edge using this locating hole and the connection matches up immediately.

### **Room to move.**

The remaining slots are routed with clearance. Minor imprecisions in the remaining domino holes are compensated for by the DOMINO connecting system – allowing fast and efficient progress.

## 1.3 The DOMINO joining machines: an overview



### DOMINO DF 500

1	SECONDARY HANDLE	6	MAINS CONNECTION	11	ON/OFF SWITCH
2	LOCKING LEVER LOCK	7	SPINDLE LOCK	12	DOMINO HOLE WIDTH ROTARY SWITCH
3	DOMINO HOLE DEPTH LOCKING LEVER	8	EXTRACTOR STUB	13	STOP CATCHES
4	ANGLE STOP CLAMPING LEVER	9	MOTOR UNIT/GUIDE FRAME UNLOCKING		
5	MATERIAL THICKNESS PRESELECT SLIDER	10	ROUTING HEIGHT ADJUSTMENT CLAMPING LEVER		





## DOMINO XL DF 700

1	HANDLES	6	ROUTING HEIGHT ADJUSTMENT PRESELECT SLIDER	11	SPINDLE LOCK
2	MOTOR UNIT/GUIDE FRAME UNLOCKING	7	ROUTING DEPTH ADJUSTMENT MARKER	12	EXTRACTOR STUB
3	DOMINO HOLE WIDTH A DJUSTMENT LEVER	8	ROUTING DEPTH ADJUSTMENT LOCKING KNOB	13	ROUTING HEIGHT ADJUSTMENT CLAMPING LEVER
4	STOP PIN UNLOCKING BUTTON	9	ROUTING DEPTH ADJUSTMENT SLIDER	14	ON/OFF SWITCH
5	ROUTING ANGLE ADJUSTMENT CLAMPING LEVER	10	MAINS CONNECTION	15	DOMINO HOLE WIDTH INDICATOR
				16	RUBBER BUFFER
				17	STOP PINS*

\*The terms stop peg and stop pin are used synonymously on the DOMINO XL DF 700.

## 1.4 Performing basic settings for the DOMINO joining machines

The DF 500 and DF 700 DOMINO joining machines are generally similar in handling and setting options. You should be aware of these in order to fully utilise the machines' flexibility. All basic settings are explained step by step below. We refer to these basic settings where appropriate in the individual application examples.



### 1.4.1 Switching on/off



To switch on the DOMINO joining machine, connect the plug-it cable to the tool, attach the extractor hose and then push the on/off switch on the top of the tool forwards and down until it locks in position.



To switch off, press the on/off switch at the rear to unlock.

## 1.4.2 Selecting hole width

This is where the unique domino slot principle comes in. The first hole, known as the locating hole, is routed appropriate to the selected domino diameter. Owing to the domino in the locating hole, the joint aligns exactly with the front edge – the joint is correctly positioned. The remaining holes are routed with clearance as slots. This makes aligning and joining effortless; the joint is nevertheless exact, perfect and stable. On the DF 500, three different hole widths can be selected, and two on the DF 700.



### DF 500

- 1 The standard width, corresponding exactly to the domino width: **13 mm** plus the cutter diameter
- 2 The average hole width, giving the domino some clearance (6 mm): **19 mm** plus the cutter diameter
- 3 The largest hole width, providing a lot of clearance (10 mm): **23 mm** plus the cutter diameter

**NOTE** Please only change the hole width by turning the rotary switch with the motor running, but never while actually routing.



### DF 700

- 1 The standard width for precise routing is: **13.5 mm** plus the cutter diameter
- 2 The hole width with clearance (3 mm) corresponds to: **16.5 mm** plus the cutter diameter

**NOTE** On the DF 700 the corresponding hole width is set using the adjusting lever on the left of the machine – the specified hole width can be seen on the display on the top of the machine.

## 1.4.3 Selecting domino length and thickness

Because selection of the domino thickness determines the selection of the cutter used, you first decide on the domino size and then employ the correct cutter (see section 1.4.4).

---

## 1.4.4 Cutter replacement

---

After selecting the domino, use the appropriate cutter to make the hole. For example, if you would like to use an 8 mm diameter domino, you also use the 8 mm cutter.



1  
Always disconnect from the mains to change the cutter.  
Then raise the unlocking lever using an open ended spanner (included) until it noticeably locks in place.



2  
Separate the motor unit and guide frame.



3  
Hold the spindle lock on the motor unit, loosen the cutter using the open ended spanner and screw off. Screw in the new cutter using the open ended spanner, keeping the spindle lock pressed. Then release the spindle lock.



4  
Before inserting a new cutter, ensure that the machine, the guide frame and the guides are clean and free from chippings. Remove any soiling. Only use sharp, undamaged and clean cutters. Now push the guide frame onto the motor unit until it audibly locks in place.

## 1.4.5 Depth adjustment range

The routing depth determines how deep the cutter cuts into the workpiece. The appropriate routing depth must be set for the different domino lengths; in most cases half of the domino length. The routing depth set on the joining machine corresponds to the depth of the domino hole.



### DF 500

Open the locking lever lock by pressing. Now set the required routing depth using the locking lever (possible depths are 12 mm, 15 mm, 20 mm, 25 mm, 28 mm). Now release the locking lever lock again.

### ATTENTION

Due to the short shaft length only the depths 12 mm, 15 mm and 20 mm are allowed when using the 5 mm diameter cutter.

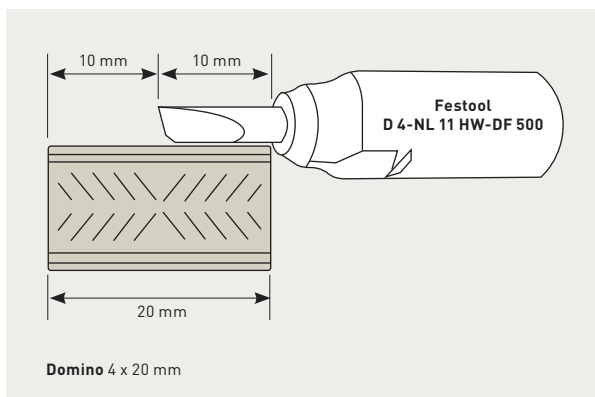

**ATTENTION** The D 4-NL 11 HW-DF 500 specialist cutter is available for the 4 x 20 mm dominos. Please use a routing depth of 20 mm when working with this domino and cutter. However, the true routing depth is 10 mm, because the specialist cutter has been shortened by 10 mm due to the risk of fracture. This domino can only be positioned centrally.



**DF 700** Press one or both locking switch to set the routing depth. Move the routing depth setting slider to the required routing depth. On the DF 700, the possible routing depth is between 15 mm and 70 mm. Now release the locking switch—briefly check that the slider has locked in to position.

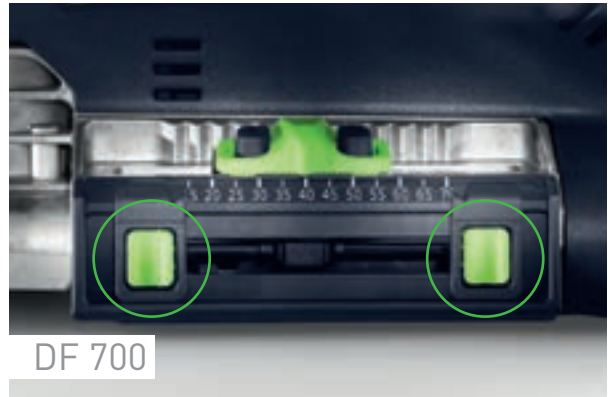

**TIP** You can mark two routing depths using the two green markers and easily move between the two using the slider. For example, this can be helpful when using a domino depth for spacing as well as for repeated, identical routing depths.

### Domino centred

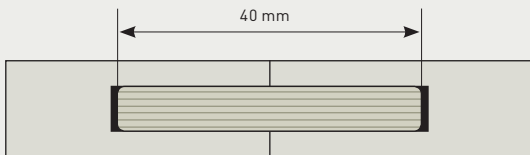

### Randomly located domino

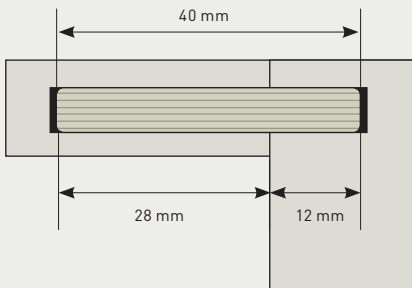

**TIP** The domino should generally be centred within the joint; that is, the routing depth should correspond to half of the domino length. However, depending on the workpiece or joint type, it may be necessary to locate the domino randomly. In this case, both of the holes routed in the workpieces must together correspond to the length of the domino being used.

**Example:** The domino being used is 40 mm long; the left hole is 28 mm deep, the right hole 12 mm – that is, together 40 mm.

### 1.4.6 Height adjustment range

The routing height setting on both the DOMINO DF 500 and the DF 700 is performed using the preselect slider, allowing predefined heights to be used. Alternatively, any individual dimension can be set using the scale. The routing height defines the distance from the workpiece top from which the hole is routed into the workpiece. Selection of the correct routing height depends on the material being worked on, and also on the type of joint to be produced on the other. Here, it is not absolutely necessary for the routed hole to be in the centre of the material. You can therefore find more information on the topic of routing height in the description of the individual applications in section 4.

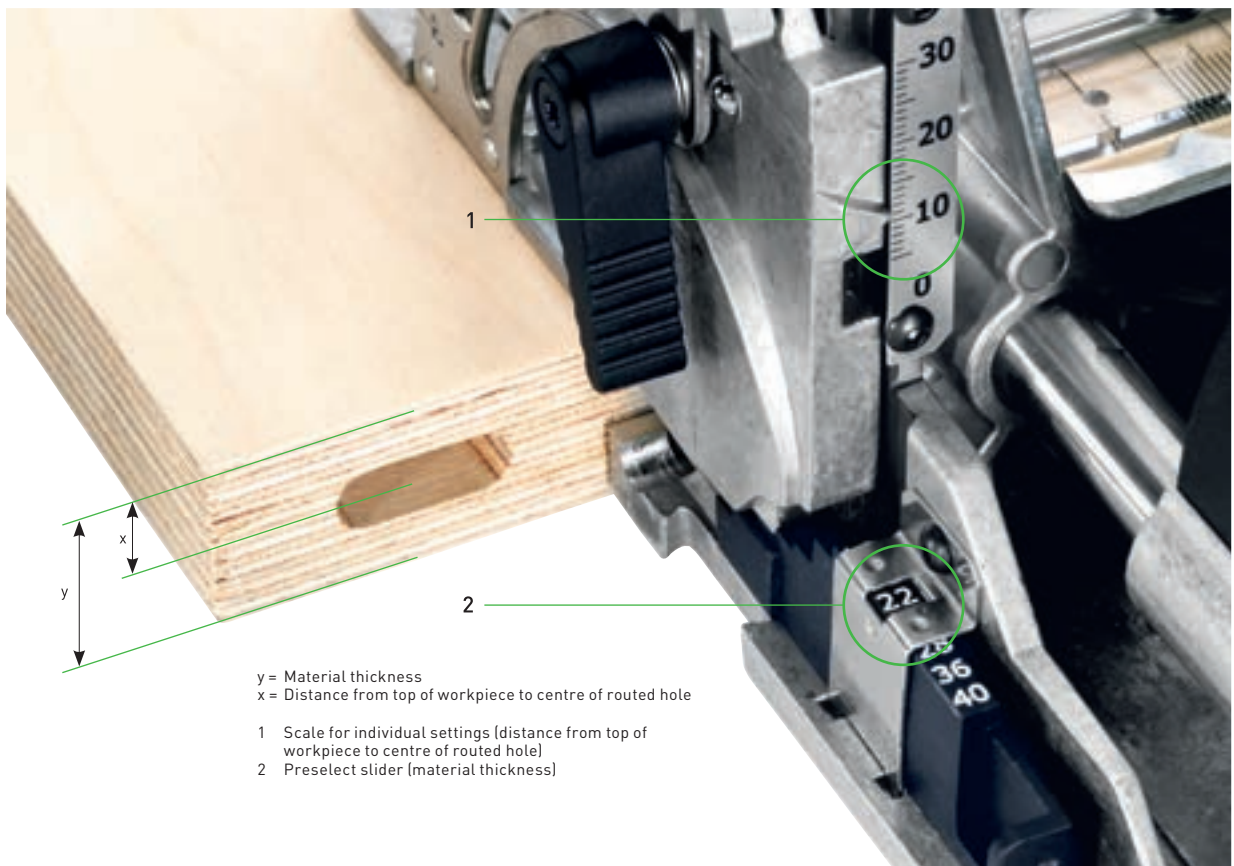

#### DF 500 – set routing height using the preselect slider.

The dimensions set using the preselect slider determine the material thickness being worked and centre the routed hole exactly in the middle of the selected disc size – without you having to calculate the distance to the centre. Release the routing height adjustment clamping lever and lift the front section of the guide frame using the secondary handle. Now select the required disc size using the slider (16 mm, 20 mm, 22 mm, 25 mm, 28 mm, 36 mm, 40 mm). Then push the front section of the guide frame downwards until it stops and close the clamping lever.



#### **DF 500 – set any routing height**

The given dimension defines the distance between the underside of the leaf and the centre of the routed hole. Loosen the routing height adjustment clamping lever and, using the secondary handle, raise the front section of the guide frame. Then push the slider towards the motor unit until it stops. Set the required routing height on the scale by moving the front section of the guide frame horizontally. Now close the clamping lever.

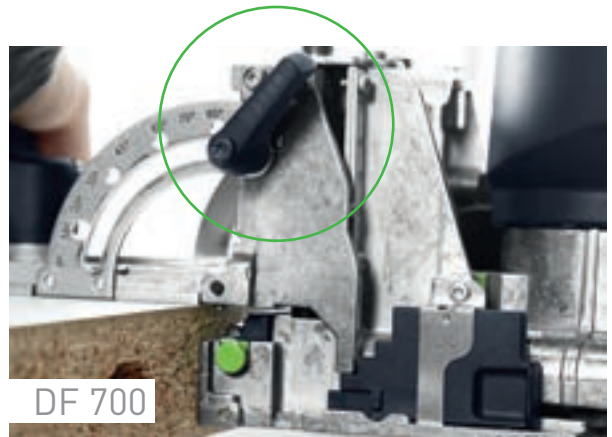

**DF 700** The routing height is adjusted on the DF 700 equivalent to the DF 500. The only difference to note: here, the preselect setting does not determine the board thickness, but instead the true distance from the top of the workpiece to the centre of the routed hole.

**NOTE** The alignment of the clamping levers can be adjusted by lifting them. In the tightened state, they should not overhang past the contact surface.



### 1.4.7 Angle adjustment range

For mitred joints, the joining machine routing angle can be set using stages, predefined angles or any other degree between 0° and 90°. The precisely machined dominos optimally align the workpiece and prevent the mitre from slipping when being glued.



**DF 500 and DF 700:** Loosen the angle stop clamping lever to adjust the routing angle. Then set the required angle, either continuously on the scale between 0° and 90° or in stages at 0°, 22.5°, 45°, 67.5°, 90°. Close the clamping lever.



**TIP** Route thin workpiece with a mitre. Set the required angle. Loosen routing height adjustment clamping lever, push the slider towards the motor unit until it stops and then push the angle stop all the way down. Close the clamping lever.

**ATTENTION** When using mitre routing, set the routing height and depth as low as possible, otherwise there is a danger that the cutter will penetrate through the opposite side of the workpiece.

**TIP** Material thicknesses from 15 mm can be mitred using the 4 x 20 mm domino.

The table shows some of the most commonly used mitre angles:

Number of equal sides	Cutting angle	DOMINO angle
3 Triangle	60	30
4 Square	45	45
5 Pentagon	36	54
6 Hexagon	30	60
7 Heptagon	25.7	64.3
8 Octagon	22.5	67.5



## 1.4.8 Working with the stop system

One of the greatest time advantages of working with DOMINO joining machines is the result of working without the need for complex measuring or marking – the machine can be positioned quickly and accurately by using stop catches (DF 500) or stop pins (DF 700).

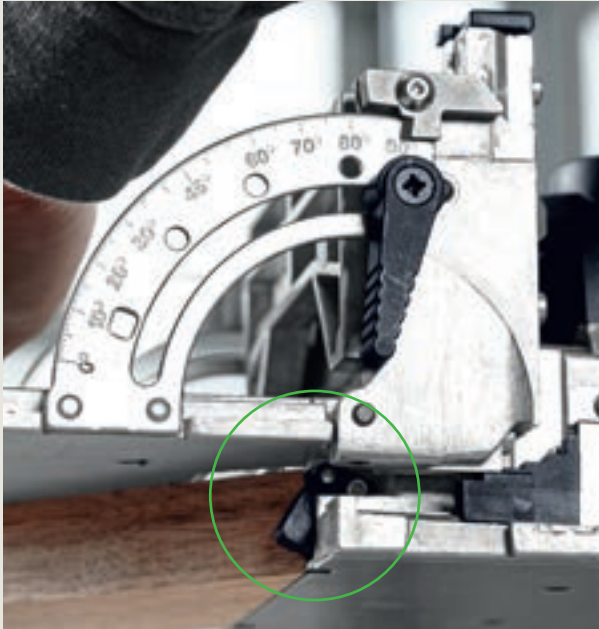

It is easiest to quickly define the positions of repetitive domino holes by using the integral stop catches for both parts of the workpiece. The distance between the stop catch and the router centre is 37 mm. Place the DF 500 at the edge of the workpiece using a stop catch.

**TIP** With the aid of the additional stop provided with the DF 500, the lateral distance to the DOMINO centre can be reduced from 37 mm to 20 mm.

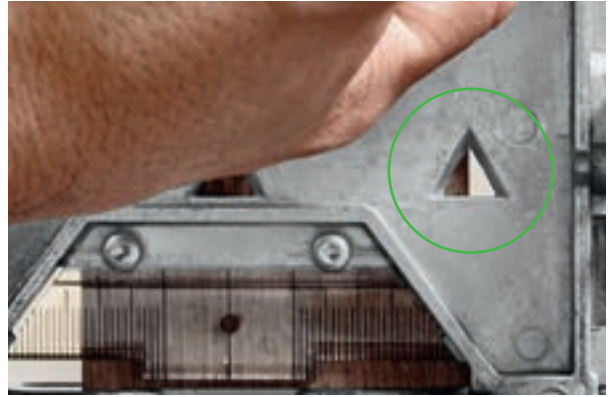

The edge of the workpiece is visible in the machine's upper triangular viewing window. If you do not need the stop catches, they are automatically pushed aside during the routing process.



**DF 500** It is possible to define the positions of the DOMINO routed holes by simply drawing and locating the machine on the scribe mark looking through the viewing window.

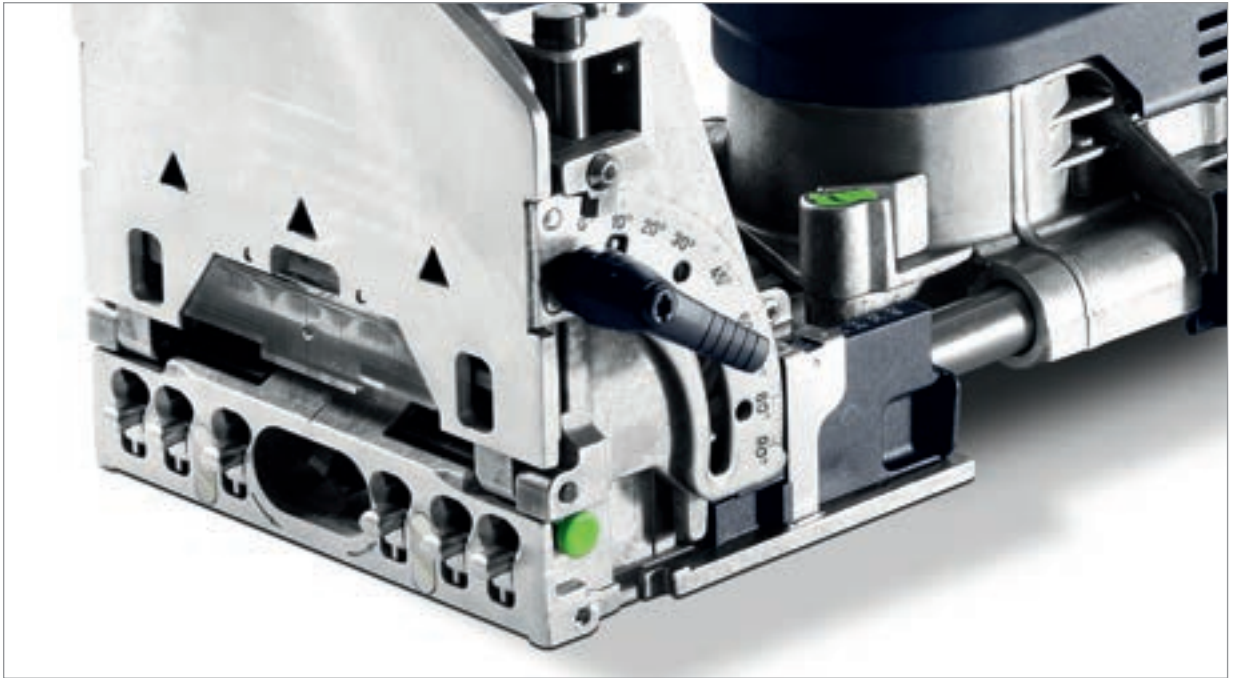

The **DF 700** possesses an innovative stop system, allowing even domino groups to be quickly and precisely positioned in relation to a reference edge using the integral stop pins.



There are six stop pins on the stop side of the joining machine. Unnecessary stop pins can be pushed aside individually and lock in place, and can all be released again by pressing the button on the side of the machine (see markings in the figure).

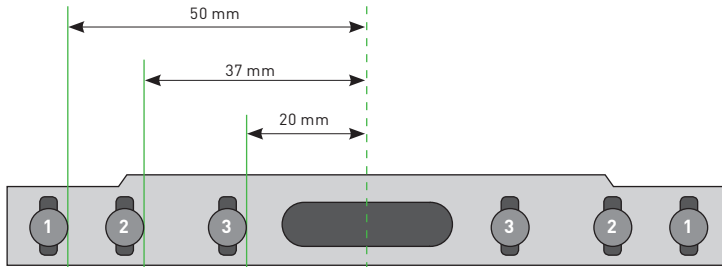

The stop pins serve as distance pieces to the router centre and can be separately located.

**A**

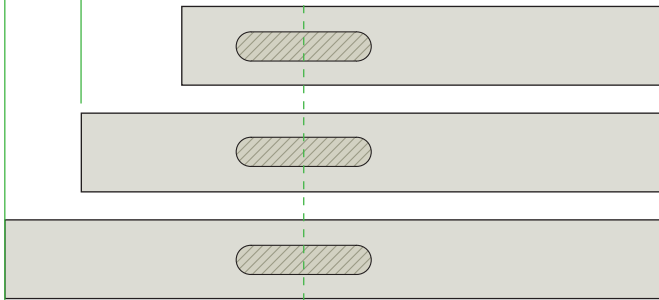

Pins (1 - 2 - 3) allow three separate distances to a reference edge.

**B**

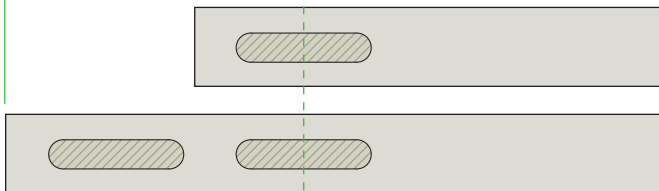

The pins allow two domino holes to be placed adjacent to each other at a defined distance to a reference edge (1 - 3).

**C**

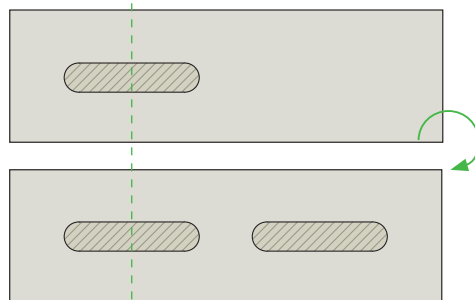

The pins allow two domino holes to be placed by rotating the workpiece, e.g. for the same moulding cross-section.

Additionally, it is possible to insert the pin in the previously routed domino hole and to use the edge of the domino hole as a stop. This means you can define domino holes over larger, uniform distances independent of the edge of the workpiece and without marking. (In the example using pin 2 in the drawing.)

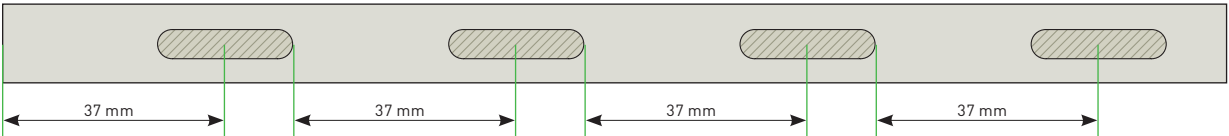

---

### 1.4.9 Working with extraction

---

Large amounts of timber chippings are created when working with the DOMINO joining machines. To improve chip transfer out of the routed hole during the routing process, and to also protect your own health, we recommend you always work with dust extraction. However, please examine all domino holes for chips after routing and empty them if necessary.



#### **Selecting the correct mobile dust extractor: it all depends on the dust category!**

In addition to improving the progress of your work, the mobile dust extractor also primarily ensures improved health when working with the DOMINO joining machines: because when working in dusty environments, in particular with materials such as timber, the dust produced can become a serious health risk. This has been shown by a recent meta-analysis\*, which established that the relative risk of asthma amongst employees exposed to timber dust is 1.53 times higher than that of the normal population.

So do yourself a favour and make sure you have clean air in your workplace – and work with a tested and approved mobile dust extractor. You will also be complying with all the statutory regulations, too.

\*Source: Perez-Rios M, Ruano-Ravina A, Etmann M, Takkouche B. A. Meta-analysis on wood dust exposure and risk of asthma. Allergy 2010;65:467-73.

The Festool mobile dust extractors were especially developed for and coordinated with our tools, and are therefore also ideal in conjunction with the DOMINO joining machines. Whether you choose a mobile dust extractor with a volume of 26, 32 or 48 litres and with or without automatic AUTOCLEAN cleaning technology, depends entirely on your personal preferences and other use preferences.



**It is important that you work with a mobile dust extractor in dust category M. This dust category is approved for all timber dusts which are created when routing with the DOMINO joining machines, but also for dusts produced by putty, fillers and cement, concrete, tile adhesives and paints such as latex and oil paints, and also materials containing sand and gravel.**







---

## The domino

2

---

---

---

---

---

---

---

## 2. The domino. The shape makes the difference.

### **Not flat. Not round. Just domino.**

The difference is in the detail. More precisely: in the shape. Dominos unify all of the benefits of round dowels and biscuits. And are therefore as stable as mortise and tenon. They are available in 14 fixed sizes or as rods – for both inside and outside, and for delicate and solid workpieces.

### **Round dowels**

---

**The traditional solution for frames and racks.**



Round dowels are one of the most important connecting elements in furniture making, allowing timber connections to be quickly and reliably aligned. Because round dowels do not allow offsets, exact drilling is generally performed on stationary or semi-stationary machines.

### **Biscuits**

---

**The standard for boards for decades.**



Biscuits are quick and always used with manually operated machines, pencil marks are used to position them. Because the biscuits are shorter than routed slots, a slight offset during routing is not a problem. The joint is movable, however this advantage is off set by the additional position during gluing up.

## Dominos

**Not flat. Not round. Just domino.**



The special shape, in combination with swelling glue pockets and longitudinal grooves, gives the dominos a secure hold. For absolutely rotation-resistant connections and maximum stability. And with substantially faster working: the first domino hole is very easily positioned and precisely routed with the aid of stop catches (DF 500) or stop pins (DF 700). It immediately aligns the workpieces, being connected exactly and flush to a reference edge. However, the DOMINO system even tolerates minor imprecisions in the additional domino holes, routed with clearance. Compared to traditional connecting elements, you always have the choice of working precisely or with clearance when working with DOMINO joining machines.

### **NEW** The domino corner and flat connectors

**As stable as dominos, but can be flexibly released again if necessary.**



## Dominos.

### 100% rotation resistant

From the very first domino, the joints are absolutely rotation resistant without additional workpiece alignment.

### Highest stability

The unique shape of the domino in combination with swelling glue pockets and longitudinal grooves, gives the dominos a secure hold.

### Fits perfectly

The DOMINO joining machines route the holes to an exact fit where needed. The domino's special groove geometry ensures a perfect precision fit.

### For inside and out

Dominos are available in two materials: Beech for interior applications and weatherproof, insect- and mould-resistant Sipo dominos for outside applications.

**Beech dominos** are certified by the Pan European Forest Council (PEFC) for timber products from sustainable, caring and responsible forest management.

**Sipo dominos** are weatherproof, and insect- and mould-resistant, and are therefore ideally suited for outside applications. They are manufactured from timber originating in sustainably managed and controlled forests.



### Always a stable connection.

The DOMINO system provides the correct dominos for every application. With its range of sizes, two timber types for inside and outside applications and additional, individually adaptable rods, there are practically no limits to this system's options.

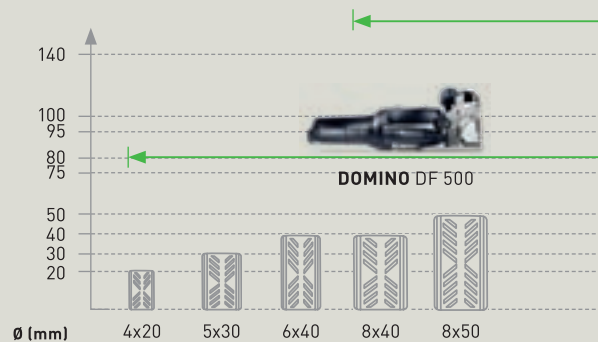

The 8-14 mm diameters are also available as rods and in two types of timber for interior and exterior applications.  
\* Flat connectors – here with the optional enlarging clips around the transverse anchor.

**Environmentally friendly**

All dominos originate from sustainable forest management. The Beech dominos are certified by the Pan European Forest Council (PEFC).

**And now also flexible**

Connect even faster. And release again if needed. The new corner and flat connectors for the DOMINO XL DF 700 guarantee a stable domino connection – but also add the option of quick release if required.



DOMINO XL DF 700

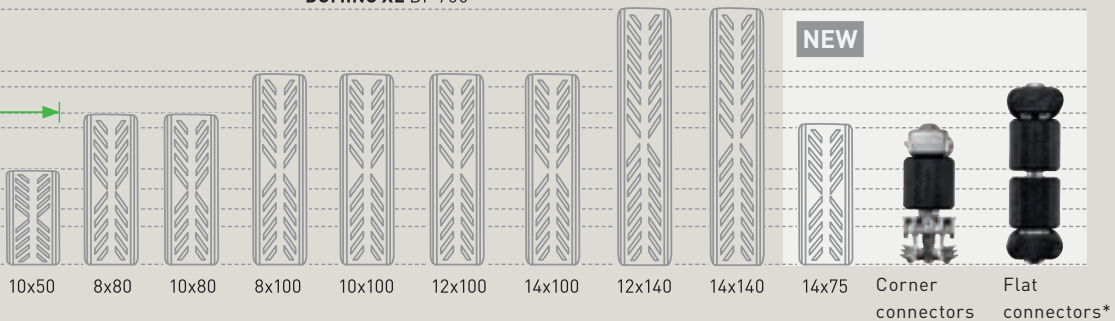



---

## DOMINO system accessories

3

---

---

---

---

---

---

---

---

### 3. DOMINO system accessories. For even greater application versatility.

The Festool system stands for application versatility and simplifies your work with accessories thought through to the finest detail: with a variety of stops, compatible with both DOMINO joining machines, even the most complicated of shapes can be easily connected.

#### Handrail fence



Timber rods in diameters from 35 – 60 mm are rotation resistantly fixed by a single domino: simply push on the handrail fence, precisely adjust, fit the workpiece and route.

(For DOMINO DF 500 and DOMINO XL DF 700)



**DETAILS** on working with the handrail fence can be found in the example applications on page 56.



## Trim stop



Trims of 22 – 70 mm width can be quickly positioned and fixed centrally using the trim stop – ideal for rack joints.

(For DOMINO DF 500 and DOMINO XL DF 700)

**DETAILS** on working with the trim stop can be found in the example applications on page 50.

## Cross stop

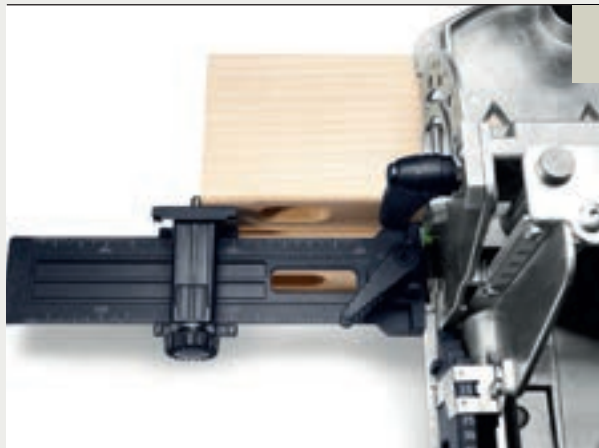

Repetitive hole centres of 100 – 205 mm can be easily transferred using the cross stop – without scribing the workpiece.

(For DOMINO DF 500 and DOMINO XL DF 700)

**DETAILS** on working with the cross stop can be found in the example applications on pages 74 and 79.

### DF 500 additional stop



The additional stop provided with the DF 500 increases the contact area and reduces the lateral distance of the stop catches to the DOMINO centre from 37 mm to 20 mm. This allows precise positioning of narrow workpieces.

### DF 700 support surface extension



The support surface extension provided with the DF 700 allows the contact area to be extended for routing on the edge of the workpiece and the machine is thus more reliably guided.

**DETAILS** on working with the additional stop and the support surface extension can be found in the example applications on page 76.

---

# Practical application examples

4

## 4.1 Overview: connections with DOMINO joining machines

The DOMINO system is ideally suited for board, frame and rack joints, involving narrow or wide, delicate or solid workpieces with dominos ranging from 4 to 14 mm in diameter or flexible, separable corner and flat connectors. In short, the DOMINO system is perfect for realising infinite connection possibilities.

The following chapter showcases examples of how to work with these various connection types. Naturally all of these examples are variable in terms of size, material, and the size and number of dominos, etc. Nevertheless, these examples always demonstrate the basic procedure which can be used as a reference.

### Applications

#### Board connections

Drawers from 4 mm dominos

Furniture making with 5 mm and 6 mm dominos

Solid timber furniture with 8 mm and 10 mm dominos

Solid timber furniture (e.g. beds) with 12 mm and 14 mm dominos

#### Rack connections

Lightweight rack construction (e.g. chairs) up to 10 mm dominos

Stable rack construction (e.g. tables) with 10 mm to 14 mm dominos

Frame and stand designs

#### Frame joints

Furniture fronts in frame design with 8 mm and 10 mm dominos

Solid timber furniture in frame design

Entrance doors and internal doors

#### Additional applications

Connection of narrow trims from a width of 25 mm

Connection of rods with handrail fence

Connection of wide rails (e.g. solid timber panels)

Corner connectors from 30 mm material thickness, separable

Flat connectors from 30 mm material thickness, separable



DOMINO joining machines

DF 500

DF 700

<input checked="" type="radio"/>	<input type="radio"/>
<input checked="" type="radio"/>	<input type="radio"/>
<input checked="" type="radio"/>	<input checked="" type="radio"/>
<input type="radio"/>	<input checked="" type="radio"/>

<input checked="" type="radio"/>	<input type="radio"/>
<input type="radio"/>	<input checked="" type="radio"/>
<input type="radio"/>	<input checked="" type="radio"/>

<input checked="" type="radio"/>	<input checked="" type="radio"/>
<input type="radio"/>	<input checked="" type="radio"/>
<input type="radio"/>	<input checked="" type="radio"/>

<input checked="" type="radio"/>	<input type="radio"/>
<input checked="" type="radio"/>	<input checked="" type="radio"/>
<input checked="" type="radio"/>	<input checked="" type="radio"/>
<input type="radio"/>	<input checked="" type="radio"/>
<input type="radio"/>	<input checked="" type="radio"/>

very suitable

suitable

## 4.2 Frame joints

The applications of the DOMINO connecting system are virtually unlimited, as well as uncomplicated. Just one domino is enough to connect a frame corner securely and ensure it will not twist – so attractive furniture fronts can be quickly and easily achieved.

With the DF 500, very small dominos can be used even for furniture joints, making it possible to process very small spindles or narrow frame rails.

With the DF 700 in contrast, stable frame joints can be created in the same way, for example, for beds, tables or internal doors. Thanks to the larger routing depth, the DF 700 is also suitable for pinned joints. Some of these connection options are demonstrated in the following examples.

### 4.2.1 Mitred frame joint



In this example, we are processing 5 x 30 mm dominos. Set the routing depth to 15 mm for this.



2  
 Select the routing height based on the workpiece; in this example, the frame is 20 mm thick. Set the routing height on the DF 500 to 20 mm in this case. The width of the frame in this example is 60 mm.



3  
 We are using two dominos per corner connector for maximum stability. Place the routing machine on the mitre cross section and carefully work with the stop catch at the side against the tip of the mitre. Route the first hole with precision.



4  
 For the second routed hole, either mark out the position or run the machine flush along the outside tip of the mitre. This routed hole can either be precisely routed like the first hole – which increases the stability of the joint but requires more precision – or it can be routed with clearance – but then you must use a sufficient amount of glue for the joint.

Use this method to route the holes in all four frame rails.



5  
 Insert the dominos, using a sufficient amount of glue, join the frame rails and brace them with clamps.

---

## 4.2.2 Butted frame joint

---

When connecting frame rails without mitring, i.e. butted joints, proceed as you normally would. This example shows another option for using the DOMINO joining machine on the workpiece.



Set the routing height to match the thickness of your workpiece. For the routing depth, select half the domino length. Route the holes by either using the right hole width for both for extreme precision fit or routing the second hole with clearance, if desired.



The routed holes can be set by marking them out as usual or using the stop system with the scale in the viewing window – in this example, 15 mm from the outside edge. For this option, place the scale with the 15 mm marking at the edge of the workpiece.





The second routed hole is set here using the stop catch. This method makes it possible to position two dominos next to each other working from just one reference edge.

**TIP** When using the stop catches, the edge of the workpiece can be seen in the triangular viewing window of the DOMINO joining machine.



Use this method to carry out routing for all four frame rails, whereby every second frame rail is routed into the workpiece lengthwise instead of into the front.



Then glue the frame rail and brace with pads and clamps, if necessary.



**TIP** If the frame rail needs to be rebated or grooved, the rebating depth must be added in advance when routing the domino holes, so that the domino is centred later despite the rebate (which then takes up part of the depth of the domino hole).

### 4.2.3 Stable frame joints with the DF 700



Use the DOMINO DF 700 for stable frame joints such as for doors, where larger dominos can be processed for even greater stability. In this example, a panel door is created with a pinned internal rebate and additional tenon.

The DOMINO joining machines are unique in that you can set the routed holes even after rebating, which would not be possible with a classic drill for conventional domino joints, for example, due to the lack of support surface. This 'pinned joint' requires small deviations in the routing depth setting, which are explained in the following.



**TIP** Due to the pinned joint, the 14 x 140 mm domino cannot be processed despite the maximum routing depth of 70 mm for the DF 700. The maximum possible standard domino is the 14 x 100 mm. However, if you wish to make full use of the maximum routing depth and cut the domino itself to the correct maximum size, you can do so by cutting the domino to the appropriate length and creating the perfect domino size yourself.



1

Mark out the desired position of the domino and work using the viewing window. Route into both parts of the workpiece at the maximum routing depth (70 mm each) with the 14 mm router.

In the end grain, set both routed holes with the correct hole width – in this case the dominos are later glued and then fit in precisely. The routing height is half of the workpiece thickness (which is 40 mm in this example, so the routing height setting is 20 mm).



2

In the lengthwise rail, set the routed holes with a 70 mm routing depth as well, but route the first hole with precision and the second as a slot with clearance. Proceed likewise for the additional lengthwise and crosswise rails.

4



3

Then cut the dominos to fit the ready-made holes. In this example, the nominal domino length is 115 mm, which is calculated by doubling the routing depth of 70 mm = 140 mm and subtracting the pinned joint of 25 mm = 115 mm. Cut the domino a few millimetres shorter (so that later the glue has enough space), down to 112 mm. Chamfer the cut domino at the edges using a sanding block.



4

Then drive the dominos all the way into the routed holes in the end grain, adding glue to the joint.

Join the lengthwise and crosswise rails using fastening clamps and glue the joint.

### 4.3 Rack joints and secure spindle positioning

Making rack joints with the DOMINO joining machine saves an incredible amount of time. Especially when relatively narrow spindles are being processed, working with the trim stop (available as an accessory or included in the DF 500 set) is recommended for safe and precise workpiece routing. This trim stop fits both the DF 500 and the DF 700 and securely holds spindles with 22–70 mm thickness.





Mount the trim stop onto the DOMINO joining machine according to the operating instructions.



Set the width of the trim stop to the thickness of your spindle by adjusting the guide in the parallel side fence to the correct dimension using the scale and the green rotary wheels. In this example, we are working with 30 x 30 mm rectangular spindles.



Using the spindle as a guide, ensure that the trim stop dimension fits perfectly; make further adjustments if necessary.



To process a 6 x 40 mm domino as in this example, use the 6 mm router (6 mm dominos can only be processed with the DF 500). For details on changing the router, see chapter 1.4.4, page 18.



Set the routing height to 15 mm, so that the domino is centred on the spindle later. Set the routing depth to 20 mm, so that the 40 mm domino is later positioned evenly between the spindle and the handrail. Route the hole in the spindles using the narrow hole setting.



**NOTE** You can naturally use the DF 700 to apply this method with a domino diameter of 8 mm or greater.



**CAUTION** Especially with handrails, it is often not possible to position the joining machine securely on the side of the workpiece due to the handrail design; the round shape prevents the DOMINO joining machine from having a secure support surface.



The trim stop provides additional support in these cases: mark out the desired position of the spindles on the handrail, where routing will take place later. From this marking, set an additional marking 10 mm away (or 15 mm when using the DF 700) – this is where the joining machine will be placed later. Then set the routing angle to 90° so that you can route vertically into the handrail from the top. The routing depth is 20 mm again, as with the spindles, with the 6 x 40 mm router to be processed.



Then set the trim stop to the width of the handrail.



Route the holes in the handrail, positioning the joining machine on the second marking.



Applying a sufficient amount of glue, insert the dominos into the routed holes and join the handrail to the spindles.



**TIP** Of course, bevelled joints are also possible with spindles needed especially for going up and down stairs. In this case, set the cutting angle of the spindle on the DOMINO joining machine during routing (using the routing angle adjustment) and route the domino hole.



Set the routed holes in the handrail as described above. Then join the spindle and handrail together.



**TIP** For workpieces where a secure support surface is possible for the joining machine, simply marking out the domino holes or central axis of the spindles is sufficient (in this case you do not have to work with the trim stop).



Set the routing height to the centre of the workpiece. Mark out the axis distance of the spindles on the top side of the workpiece. In this case (when simply using markings) bring the scale in the viewing window of the DOMINO over the scribe mark and set the routed holes. A second scribe mark, as in the example of the handrail above, is not necessary here.





## 4.4 Round profile joints



When connecting round timber profiles, such as those used for handrails, the handrail fence is available as an accessory to ensure a secure workpiece hold. This part fits both the DF 500 and the DF 700 for diameters from 35–60 mm. The following example describes how a stop is created using this handrail.



Before starting, ensure that the correct router is used. In this example, we are processing an 8 x 40 mm domino, so the 8 mm router must be used.

Set the routing depth to 20 mm.

Select the routing height so that the domino is offset towards the inside of the mitre, preventing the routing from going through the workpiece. In our example with a round timber profile with 40 mm diameter, set the routing height to 20 mm.



Mount the handrail fence onto the DOMINO DF 500 or DF 700 according to the operating instructions.

**TIP** Before processing your workpiece, it is important to create a sample piece and make fine adjustments to the handrail fence according to the operating instructions.



The handrail fence holds the workpiece securely and centres it automatically thanks to the prism-shaped contact surfaces.

4



Set the routing angle on the joining machine according to your sawing angle on the workpiece. In our example, the handrail was sawed at 15°, which means the routing angle is set to 75°; this is equal to 90° minus 15°. Secure the workpiece, on the MFT multifunction table. Then route the hole in both parts of the workpiece.



Insert the 8 x 40 mm domino into the routed hole, applying glue to the joint. Then join the two workpiece parts together – the joint is secured from twisting with just one domino!

## 4.5 Stable, separable corner connectors



The separable corner connectors provide even more flexibility, especially with large, solid workpieces like tables or beds. These connectors allow for quick and easy assembly and disassembly of furniture pieces, making transport a breeze. In terms of how they are processed, the connectors are very similar to the securely glued dominos to a great extent and can be easily mounted thanks to the large pulling and tightening distance.

The example provided here demonstrates how to create a table or bedpost.



For corner connectors, you need the following components from the DOMINO corner and flat connector system:

Dimensions for routing the DOMINO corner connector

	Hole width	Routing depth	Routing height
A		25 mm	-y/2
B		50 mm	-y/2
C		x + min. 10 mm; min. 25 mm in total	40 mm

Only suitable for joining timber or timber-like materials in furniture construction (no lightweight building materials!) The DOMINO connector is only a connecting element, not a load-bearing element. Observe minimum routing depths and edge distances! For indoor use only!



Per corner connector:

**1 x anchor bolt** including DOMINO connector cover

**1 x transverse anchor** including stud

**1 x expansion bolt**

**Optional: 1 x cover cap** in silver, light brown or dark brown

The corner and flat connectors are always processed with the 14 mm router on the DF 700.



Set the routing depth of the joining machine to 25 mm – set the markers to 25 mm and 50 mm.



It is a good idea to work with the stop pins in this case. Select the pins depending on the desired hole distance. Ensure that the routing for the corner connector has a minimum distance of 37 mm from the edge of the workpiece. If you work with the stop pins, use the centre pin at least.



Route the domino holes in the table or bedpost (narrow hole width) with a routing depth of 25 mm. Set one hole for the expansion bolt of the corner connector, the others for the load transfer via traditional dominos.





Change the routing depth to 50 mm and route the holes (narrow hole width) in the frame according to the scribe mark or using the stop pin system. The routing height is determined by the material thickness, using the usual method you already know from working with your DOMINO DF 700. In this example, the frame has a material thickness of 30 mm. Set the routing height to 15 mm so that the routed hole is centred in the material.



Then set the routing depth to 25 mm for routing the transverse hole. (This dimension depends on the workpiece; see dimensional drawing. What is important to note is that the transverse hole should overlap the longitudinal hole by 3 mm in depth.)



The flip stop point, i.e. the routing height adjustment, must always be set to 40 mm. This ensures that the transverse hole always sits at the right distance to the edge of the workpiece and that the anchor bolt then catches the transverse anchor.



Then route the transverse hole into the frame, where the connector will be inserted. Flip the handle down at the front of the edge of the workpiece and align the machine at the scribe mark or using the stop pins (depending on how the horizontal routed hole was set).

**TIP** For a bigger and therefore safer support surface, it is possible and would be beneficial during this routing process to mount the support surface extension onto the DF 700.



8

Insert the expansion bolt into the centre routed hole in the post.



9

It is important to ensure that the expansion bolt is flush with the workpiece surface.



10

Then screw the anchor bolt all the way into the expansion bolt. This expands the expansion bolt, pulling it another approx. 1 mm into the workpiece thanks to the self-drawing property of the bolt and locking it securely into place. A 10 mm open ended spanner is used for this.

**TIP** Alternatively, a 4 mm hexagonal socket can be inserted through the hole or a ratchet with a 10 mm socket can be used.



11

Then unscrew the bolt just enough so that the countersink is facing the right direction. The expansion bolt is now sitting securely in the workpiece and cannot fall out of the routed hole, even if the joint is disassembled for transport purposes.





12

Clip the two DOMINO connector covers around the anchor bolt. These are used to hold the corner connector flush against the workpiece.



13

The transverse anchor is then inserted into the transverse hole in the side wall, with the screw hole facing upwards.



14

Press the transverse anchor all the way into the routed hole using the spanner.



15

Then insert the threaded screw. Tighten it only so that the screw stays in place, but the opening remains open for the anchor bolt.



16

Then join the frame to the post by pushing the connector and dominos into their respective holes.



**TIP** It is usually a good idea to fit flexible connectors to one of the sides and securely glue dominos into the other side.



Tighten the connection using a 4 mm hexagonal socket.



Optionally, you can cover the routing with a cover cap, available in one of three colours depending on the material: silver, light brown or dark brown.



This is a quick way to create a stable joint that can be quickly disassembled if necessary, without time-consuming measuring or marking.

## 4.6 Stable, separable flat joints



The DOMINO flat connector is ideal for creating stable flat joints that are separable. You can connect plates, kitchen worktops or other surfaces, quickly and flexibly.

This application example demonstrates how to connect a kitchen worktop.

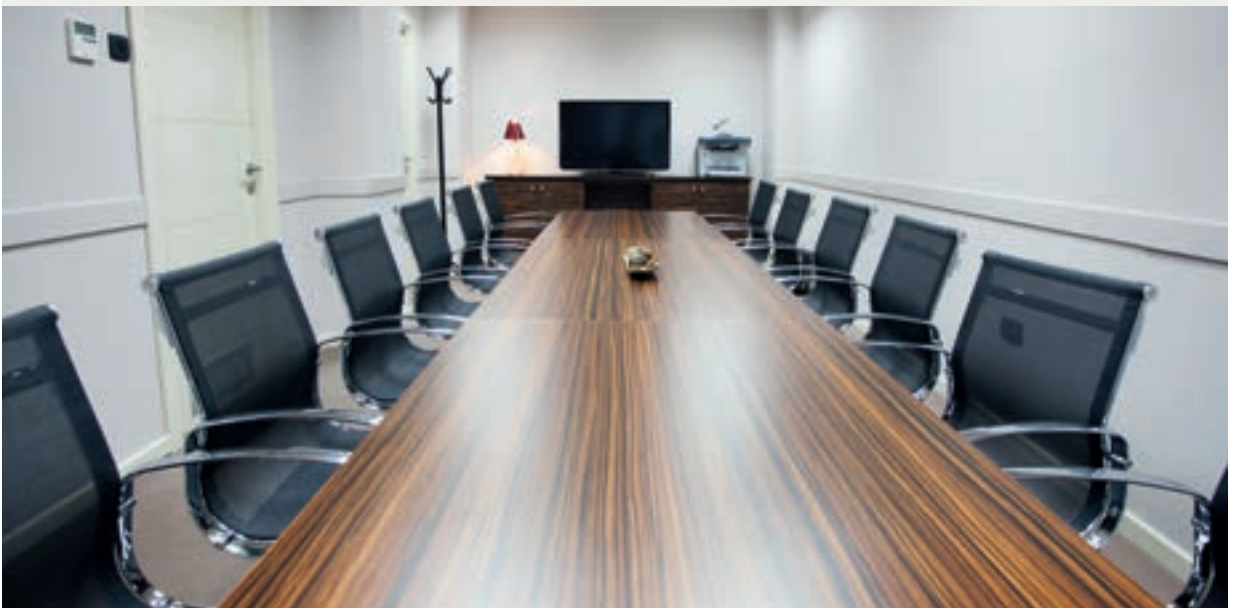

For flat joints, you need the following components from the DOMINO corner and flat connector system:



1. Transverse anchors – here with additional widening. Prevents the transverse anchor from drawing into soft materials (e.g. kitchen worktops).
2. Double-headed bolt – can be used with one or two domino clips.
3. DOMINO connector covers – clipped around double-headed or anchor bolts. Items included with double-headed or anchor bolts.

Flat connector with enlarging clips around the transverse anchor – specially designed for materials such as kitchen worktops.

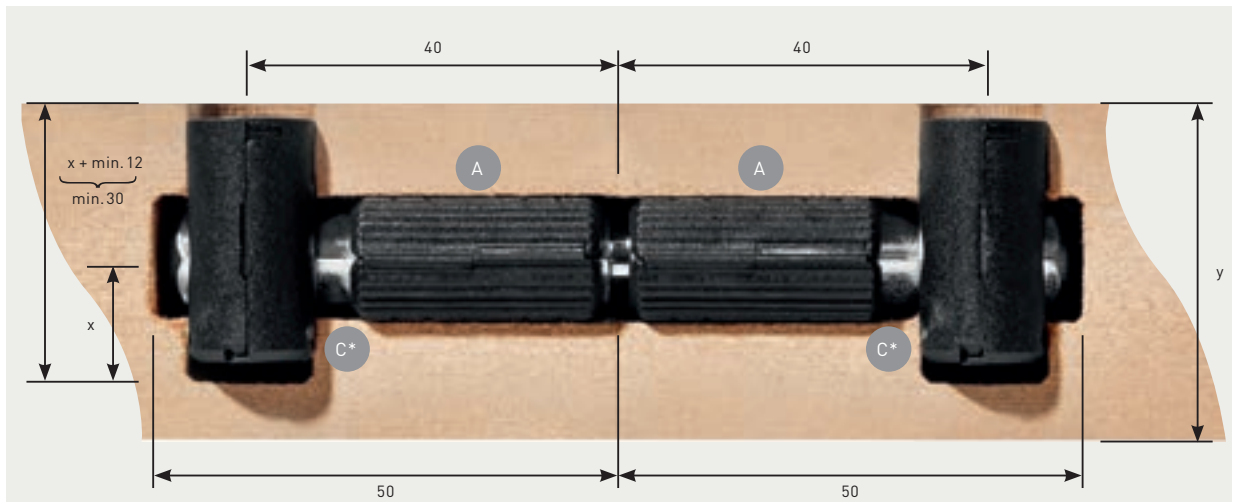

	Hole width	Routing depth	Routing height
A			
		50 mm	~y/2

When working without enlarging clips around the transverse anchor:

C		x + min. 10 mm; min. 25 mm in total	40 mm
---	--	---	-------

When working with enlarging clips around the transverse anchor:

C*		x + min. 12 mm; min. 30 mm in total	40 mm
----	--	---	-------

Only suitable for joining timber or timber-like materials in furniture construction (no lightweight building materials!) The DOMINO connector is only a connecting element, not a load-bearing element. Observe minimum routing depths and edge distances! For indoor use only!

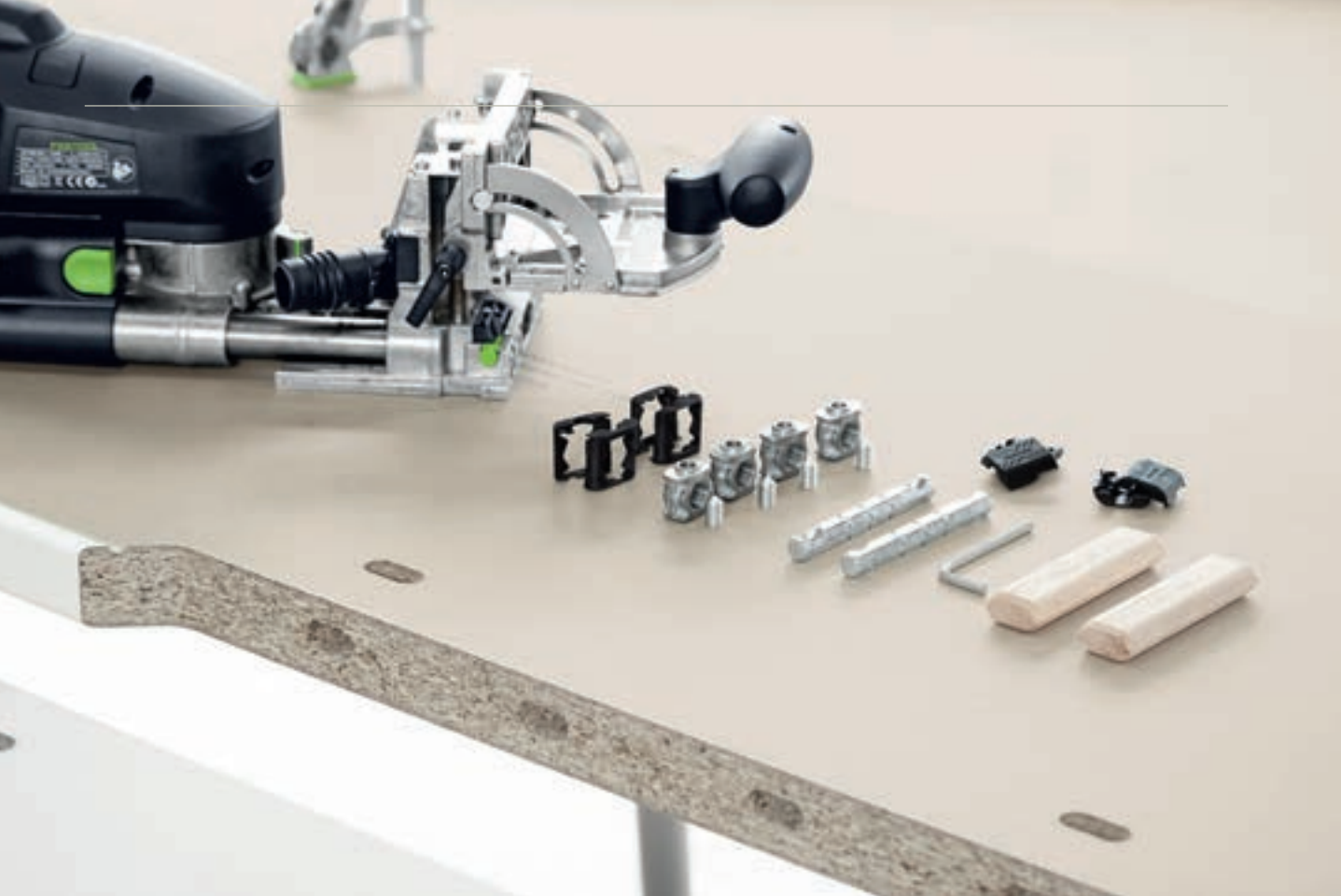

For this connection, you need at least two flat connectors and the following components from the DOMINO corner and flat connector system:

**2 x double-headed bolts** including DOMINO connector covers

**4 x transverse anchors** including studs

**Optional: 8 x enlarging clips** for the transverse anchors

**Optional: 2 x dominos D14 x 75**

**Optional: 4 x cover caps** in silver, light brown or dark brown



1

Mark out the connector position on the surface of the worktop at the desired point. Also mark the positions for additional dominos (used to ensure a flush connection).



2

Transfer the markings to the abutting surfaces of the worktop. It is sufficient to do this where you later want to insert the flat connectors.



3

Insert the 14 mm router.

4



4

Set the routing height: the distance from the flip stop to the centre of the router should be half the worktop thickness. With a worktop thickness of 38 mm, for example, set the routing height to 20 mm.



5

Then set the routing depth to 50 mm and set the markers to 50 mm and 30 mm.



Route the 50 mm deep holes with the narrow hole width into both workpieces at the markings. The joining machine is placed on the top side of the worktop in this case.



Switch the machine to the large hole width for the transverse holes; this gives the transverse anchors enough space when fitted with the enlarging clips.



Then set a routing depth of 30 mm – this dimension depends on the material. What is important to note is that the transverse hole should overlap the longitudinal hole by 5 mm in depth. If using the transverse anchors without enlarging clips, an overlap of 3 mm suffices. The routing height should be set to 40 mm – this setting is identical for each connector, because it is based on the length of the connector. Route transverse holes in both workpieces at the points where the flat connectors will be inserted.





9

The enlarging clips around the transverse anchors prevent the anchors from drawing into soft materials (e.g. kitchen worktops) when tightened. Clip the enlarging clips around the transverse anchors for this purpose.



10

Tighten the studs in the transverse anchor only so that the studs stay in place, but the opening remains open for the double-headed bolt.



11

Insert the transverse anchors into the routed holes.



12

If you have decided to use additional dominos in order to ensure a flush connection and extra transverse load transmission, insert these into the other routed holes.



13

Clip the domino clips around the double-headed bolt.

**TIP** The double-headed bolt can be fitted with one or two domino clips.

With one domino clip, the clip sits flush and neatly between both workpieces.

With two domino clips, the double-headed bolt has some clearance later for the alignment, because the clips each sit in a half of the workpiece.

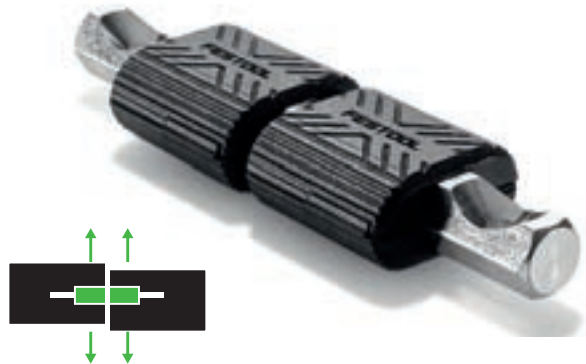



14

Then push the double-headed bolt into the workpiece...



15

...and tighten the stud in the first transverse anchor.



16

Push both workpieces together...

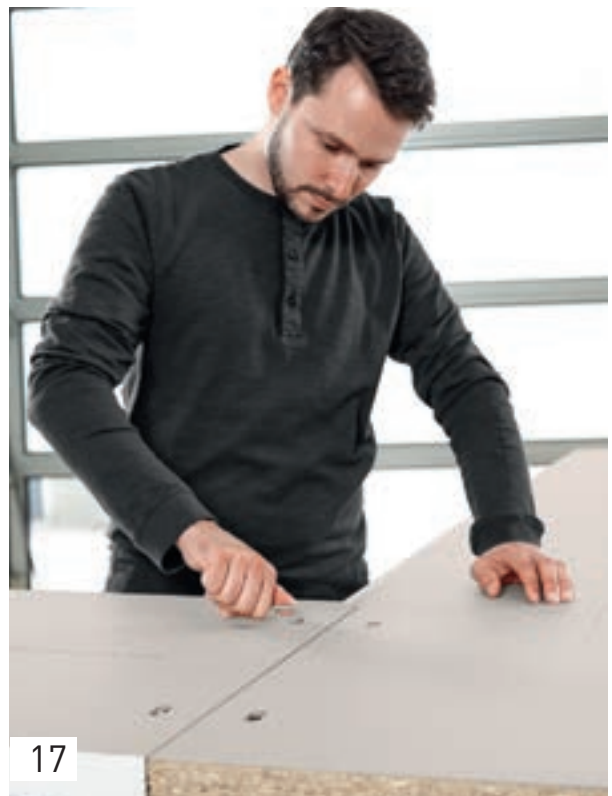

17

...and clamp the connectors by tightening the stud on the second workpiece side.



**TIP** In general, these connections are located on the bottom of tabletops and kitchen worktops, i.e. outside of visible area. Nevertheless it is possible, of course, to cover the transverse holes with cover caps.

## 4.7 Mitred joints



Mitred joints are not just possible for smaller workpieces and frames – naturally they can also be used for stabler connections of solid workpieces thanks to the DF 700. The following example uses a bench to show how these types of joints are quickly and easily created using the DOMINO stop pins of the DF 700.



Our workpiece is 30 mm thick. We are processing dominos with 8 x 40 mm thickness. The mitre angle is 45°. This requires the following settings on the joining machine: adjust the routing height to the smallest setting, 10 mm. The routing angle is 45° and the routing depth is half of the domino length, i.e. 20 mm.



Use the stop pin system to select the hole distance based on the individual workpiece. In this example, we are working with the two centre pins, to create a hole distance of 37 mm.



After routing the first hole (the pin is positioned at the edge of the workpiece in this case), the pin goes into the routed hole, thus setting the next stop. Route the first hole with precision, and all other holes as slots with clearance.



Then join the workpiece parts together, gluing the dominos carefully in the process.



**TIP** For larger hole distances, you can work with the cross stop (available as an accessory or included in the DF 500 set) both with the DF 500 and the DF 700.

## 4.8 Drawer connections

Even thin cross-sections from 12 mm can be joined perfectly with the DF 500, using the small 4 x 20 mm dominos and the appropriate 4 mm router. The 4 x 20 mm domino is suitable for right-angle connections in thin workpieces or mitred joints from a 15 mm thickness.





1

To process the smallest domino (4 x 20 mm), insert the 4 mm router into the DOMINO DF 500. This router is unique in that it is shortened by 10 mm. Therefore, at the maximum routing depth of 20 mm, the routed hole is only 10 mm deep.



2

Set the additional stop on the DOMINO DF 500. This uses the additional stop pins to reduce the lateral distance to the centre of the DOMINO router from 37 mm to 20 mm.

4



3

Set the routing depth to 20 mm, the routing height to the minimum and the routing angle to 45°.



4

Flip the additional stop pin from the additional stop and place the joining machine on the workpiece – the routed holes will be further offset from the edge of the workpiece, which is beneficial with such narrow workpieces.

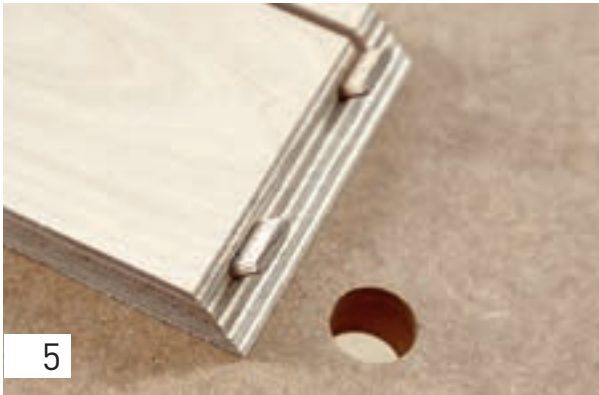

Insert the dominos into the routed holes, glue them ...



... and join the workpiece together.



**NOTE** Of course, butted joints are also possible using the smallest domino. Proceed as described above and route the domino holes on the front side using the additional stop.

The additional stop also provides a secure support surface when clamped vertically.



Join the workpiece and glue it together.



## 4.9 Butted panel joint

4

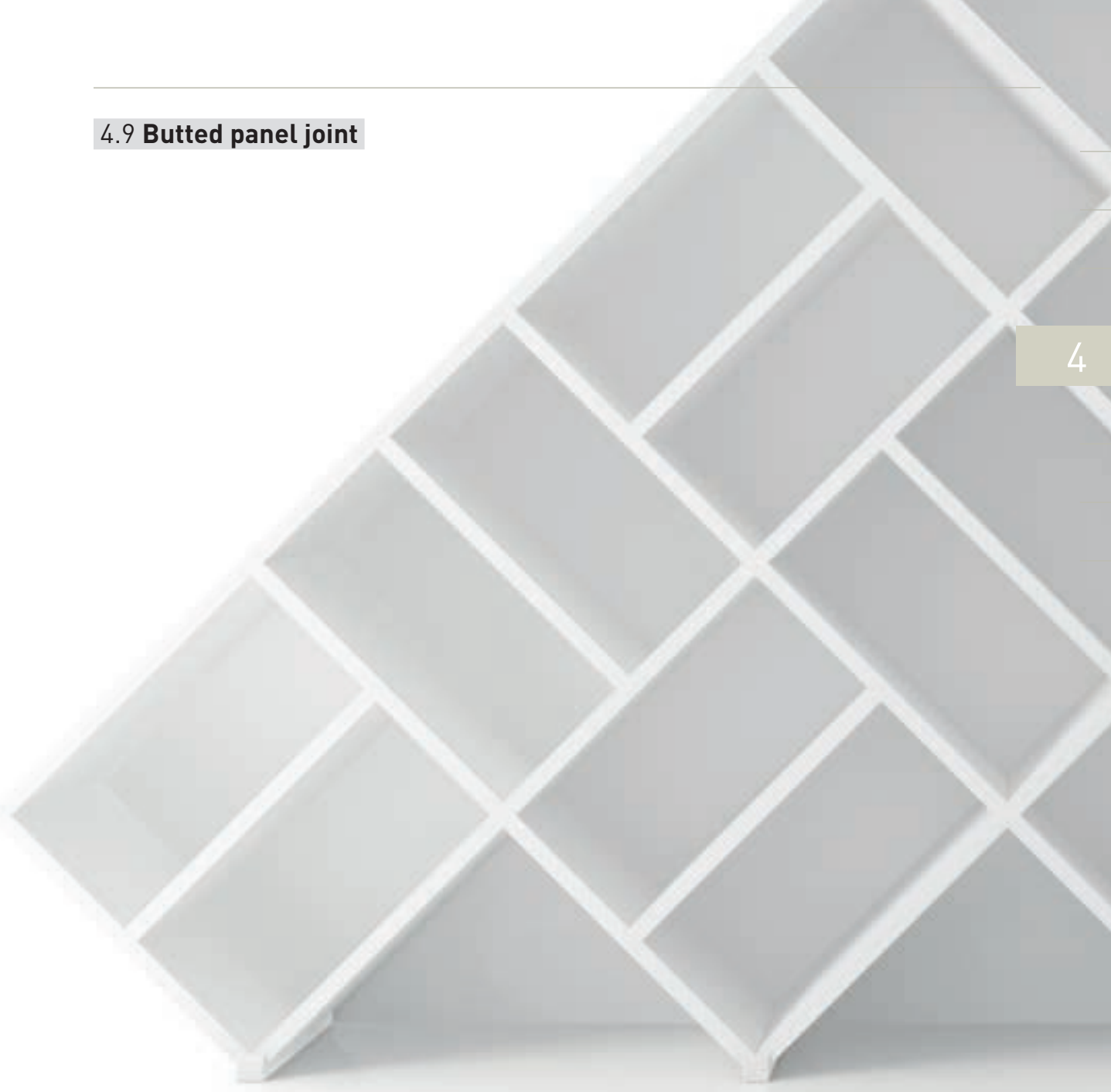

Panel joints like those for cupboard or shelving units can be ideally created with the DOMINO joining machines. The following example shows how to create a unit with the DF 500.



1  
With larger workpiece widths and larger hole distances, the cross stop can be used to work easily with the stop pin system instead of marking out holes.

**TIP** The cross stop can be used both for the DF 500 and the DF 700 and allows for larger hole distances beyond the stop pin system. Ensure that the stop is fitted onto the machine in use.



2  
To fit the cross stop on the machine in question, turn the clamp jaw on the stop pin so that it is set to the DF 500 or DF 700 position (each machine is marked accordingly on the front of the pin).



3  
Mount the cross stop onto the joining machine according to the operating instructions. In this example, we are processing 6 x 40 mm dominos.

Due to the material thickness of 19 mm, the domino cannot be inserted into both workpiece parts (front and surface) with 20 mm on each side.



4  
For this reason, a routed hole with a depth of 25 mm is created (on the front side) for this butted joint. The other routed hole (on the surface) is 15 mm deep, so that the total domino length of 40 mm is processed.

Place the joining machine at the front edge of the workpiece with the stop pin for the first routed hole, and route the hole with the appropriate hole width.



For the other routed holes, set the desired hole distance on the cross stop and position the pin in the first routed hole. Route the other holes as slots.



Use the same process to create the routed holes for the side wall of the cabinet. Set the first hole with the stop pin of the DOMINO joining machine...



...and create the others using the cross stop pins. Using the additional stop, along with the cross stop – is beneficial here, because the joining machine has a sturdy support surface on the panel.



Then create the routed holes for the shelves (this process is similar for carcass sides etc).

Place both side parts on top of each other and mark out the position where the centre shelf will be. Mark the top and bottom edge of the shelf (material thickness), not the centre.



Place the top side part to one side. Position the centre shelf at the marked point and fold it over towards the right or left, so that the top or bottom edge of the centre shelf is aligned with the corresponding marking. Clamp both workpieces (centre shelf and side part).

**TIP** If the centre shelf will be reset at the end, keep this in mind even when clamping.



In our example, the centre shelf and side part are flush at the front and are clamped accordingly. Adjust the angle of the joining machine to 0° and the routing depth to 15 mm. Then route the first domino hole with the narrow hole width with the stop pin in the horizontal side part.



For the other domino holes, switch the hole width to the slot and mark out the domino positions with a simple scribe mark on the horizontal centre shelf. Then place the joining machine on the scribe mark. Use the markings placed on the bottom of the joining machine by positioning the centre marking on the machine at the scribe mark on the shelf.



Switch the routing depth to 25 mm and route the domino holes in the centre shelf, again using the stop pin for the first routed hole (narrow hole width).

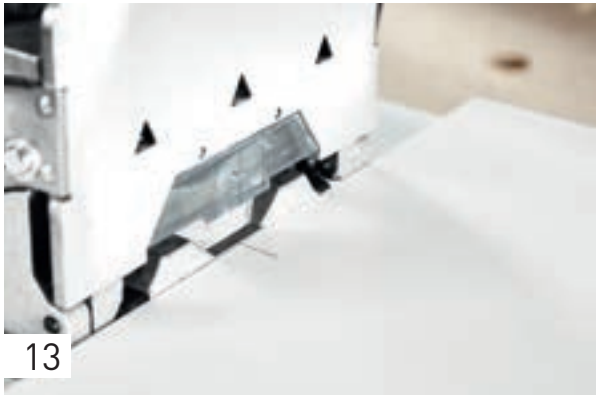

Set the other holes using the scale in the viewing window, which you align with the scribe marks. Set all holes here in the panel edge with the narrow hole width – the domino will be glued here first and will then fit in precisely.



Proceed likewise for the second side part. Then insert the domino in the routed holes and join your workpiece together, applying glue to the joint.

4





# Items included, specifications

5



## 5. Items included, specifications



### DOMINO DF 500 Items included

#### DF 500 Q-Plus

574325

DOMINO D 5 router, support bracket, accessory tool set, in a SYS 2 T-LOC SYSTAINER

#### DF 500 Q-Set

574427

DOMINO D 5 router, support bracket, trim stop, cross stop, accessory tool set, in a SYS 2 T-LOC SYSTAINER

### DOMINO DF 700 Items included

#### DF 700 EQ-Plus

574320

DOMINO D 12 router, support bracket, 2x domino box, accessory tool set, in a SYS 5 T-LOC SYSTAINER

## Specifications

	DOMINO DF 500	DOMINO DF 700
Power consumption (W)	420	720
Idle engine speed (min <sup>-1</sup> )	25,500	21,000
Depth stop for routing depth (mm)	12, 15, 20, 25, 28	15–70
Max. routing depth (mm)	28	70
DOMINO slot cutter (mm)	4, 5, 6, 8, 10	8, 10, 12, 14
Routing height adjustment (mm)	5–30	10–50
Mitre routing (°)	0–90	0–90
Dust extractor connection (mm)	27	27
Weight (kg)	3.2	5.2



---

## Accessories

6

---

---

---

---

---

---

---

## 6. Accessories

### 6.1 Cutters

#### Cutters for DOMINO DF 500 joining machine

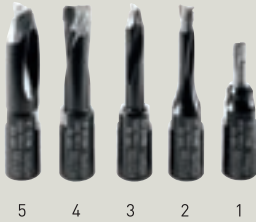

1	<b>D 4-NL 11 HW-DF 500 router</b> D 4 mm, NL 11 mm, in self-service display pack	495663
2	<b>D 5-NL 20 HW-DF 500 router</b> D 5 mm, NL 20 mm, in self-service display pack	493490
3	<b>D 6-NL 28 HW-DF 500 router</b> D 6 mm, NL 28 mm, in self-service display pack	493491
4	<b>D 8-NL 28 HW-DF 500 router</b> D 8 mm, NL 28 mm, in self-service display pack	493492
5	<b>D 10-NL 28 HW-DF 500 router</b> D 10 mm, NL 28 mm, in self-service display pack	493493

#### Cutters for DOMINO XL DF 700 joining machine



1	<b>D 8-NL 50 HW-DF 700 DOMINO router</b> Cutter with thread inserts for the DOMINO XL DF 700 joining machine, D 8 mm, NL 50 mm, in self-service display pack	497868
2	<b>D 10-NL 70 HW-DF 700 DOMINO router</b> Cutter with thread inserts for the DOMINO XL DF 700 joining machine, D 10 mm, NL 70 mm, in self-service display pack	497869
3	<b>D 12-NL 70 HW-DF 700 DOMINO router</b> Cutter with thread inserts for the DOMINO XL DF 700 joining machine, D 12 mm, NL 70 mm, in self-service display pack	497870
4	<b>D 14-NL 70 HW-DF 700 DOMINO router</b> Cutter with thread inserts for the DOMINO XL DF 700 joining machine, D 14 mm, NL 70 mm, in self-service display pack	497871

## 6.2 Stops

### Stops for **DOMINO DF 500 joining machine** and **DOMINO XL DF 700**



#### **QA-DF 500/700 cross stop**

for DF 500 and DF 700, items included: a left and a right cross stop, for repeated hole centres of 100–205 mm, for exact positioning of routing with edge distances of 100–205 mm, in self-service display pack

498590

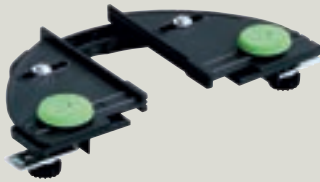

#### **LA-DF 500/700 trim stop**

for DF 500 and DF 700, for 22–70 mm wide trims, qty. in pack 1 pc., in self-service display pack

493487



#### **RA-DF 500/700 handrail fence**

for DF 500 and DF 700, for wood rods of 35–60 mm, for precisely routing rods  $\varnothing$  35–60 mm, in self-service display pack

494847



#### **ZA-DF 500 additional stop for DF 500 only**

Support surface extension and parallel side fence for reducing the domino centre from 37 mm to 20 mm, for safely locating the router, in self-service display pack

495666

### 6.3 Dominos and connectors

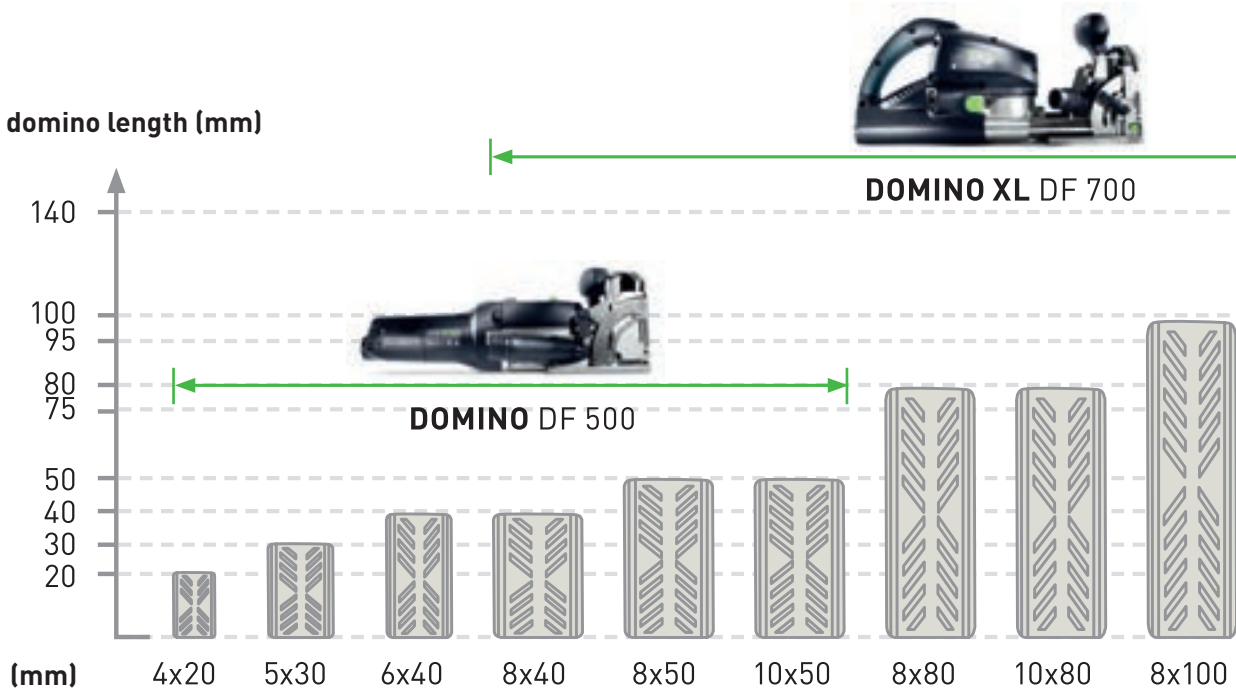

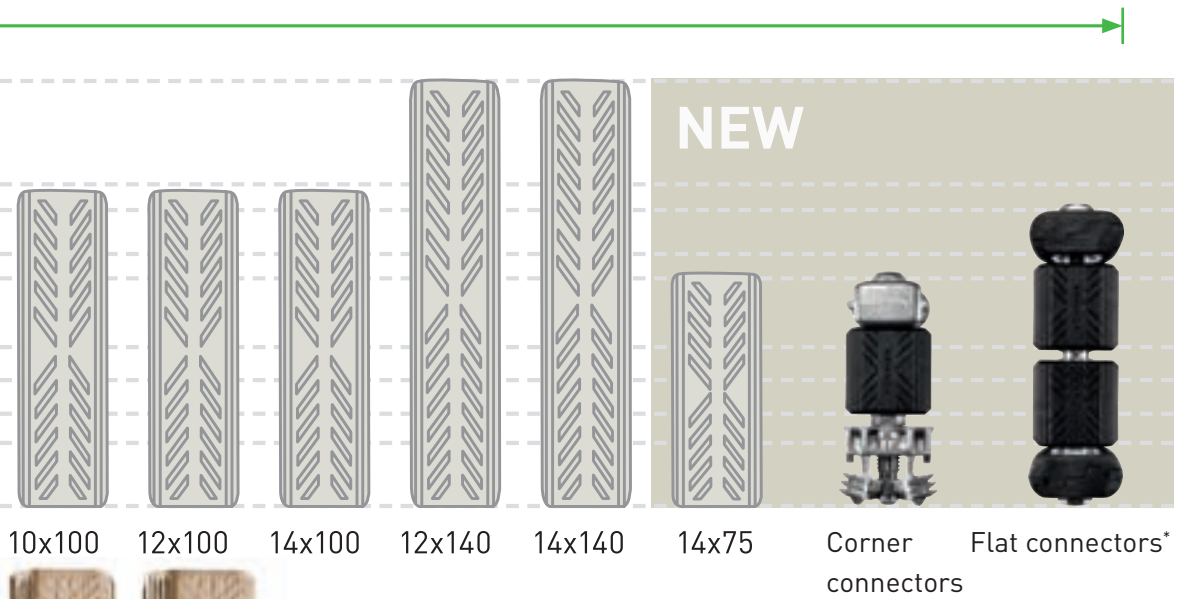

\* Flat connectors - here with the optional enlarging clips around the transverse anchor.



## 6.3.1 Dominos and Dominos Beech



<b>Domino, Beech D 4 x 20/450 BU</b> Dimensions 4 x 20 mm, qty. in pack 450 pcs, in self-service display pack	495661
<b>Domino, Beech D 5 x 30/300 BU</b> Dimensions 5 x 30 mm, qty. in pack 300 pcs, in self-service display pack	494938
<b>Domino, Beech D 5 x 30/1800 BU</b> Dimensions 5 x 30 mm, qty. in pack 1800 pcs, in carton	493296
<b>Domino, Beech D 6 x 40/190 BU</b> Dimensions 6 x 40 mm, qty. in pack 190 pcs, in self-service display pack	494939
<b>Domino, Beech D 6 x 40/1140 BU</b> Dimensions 6 x 40 mm, qty. in pack 1140 pcs, in carton	493297
<b>Domino, Beech D 8 x 40/130 BU</b> Dimensions 8 x 40 mm, qty. in pack 130 pcs, in self-service display pack	494940
<b>Domino, Beech D 8 x 40/780 BU</b> Dimensions 8 x 40 mm, qty. in pack 780 pcs, in carton	493298
<b>Domino, Beech D 8 x 50/100 BU</b> Dimensions 8 x 50 mm, qty. in pack 100 pcs, in self-service display pack	494941
<b>Domino, Beech D 8 x 50/600 BU</b> Dimensions 8 x 50 mm, qty. in pack 600 pcs, in carton	493299
<b>Domino, Beech D 10 x 50/85 BU</b> Dimensions 10 x 50 mm, qty. in pack 85 pcs, in self-service display pack	494942
<b>Domino, Beech D 10 x 50/510 BU</b> Dimensions 10 x 50 mm, qty. in pack 510 pcs, in carton	493300

<b>DOMINO, Beech D 8 x 80/190 BU</b> Dimensions 8 x 80 mm, qty. in pack 190 pcs, in carton	498212
<b>DOMINO, Beech D 8 x 100/150 BU</b> Dimensions 8 x 100 mm, qty. in pack 150 pcs, in carton	498213
<b>DOMINO, Beech D 10 x 80/150 BU</b> Dimensions 10 x 80 mm, qty. in pack 150 pcs, in carton	498214
<b>DOMINO, Beech D 10 x 100/120 BU</b> Dimensions 10 x 100 mm, qty. in pack 120 pcs, in carton	498215
<b>DOMINO, Beech D 12 x 100/100 BU</b> Dimensions 12 x 100 mm, qty. in pack 100 pcs, in carton	498216
<b>DOMINO, Beech D 12 x 140/90 BU</b> Dimensions 12 x 140 mm, qty. in pack 90 pcs, in carton	498217
<b>DOMINO, Beech D 14 x 100/80 BU</b> Dimensions 14 x 100 mm, qty. in pack 80 pcs, in carton	498218
<b>DOMINO, Beech D 14 x 140/70 BU</b> Dimensions 14 x 140 mm, qty. in pack 70 pcs, in carton	498219



### T-LOC SORT-SYS DOMINO

Empty SYS 2 T-LOC systainer contains 3 boxes with flexible compartments for individual filling with dominos, SYS 2 T-LOC SYSTAINER

498889



<b>Domino rod, Beech D 8 x 750/36 BU</b>	498686
Dimensions 10 x 750 mm, qty. in pack 36 pcs, in carton	
<b>Domino rod, Beech D 10 x 750/28 BU</b>	498687
Dimensions 10 x 750 mm, qty. in pack 28 pcs, in carton	
<b>Domino rod, Beech D 12 x 750/22 BU</b>	498688
Dimensions 12 x 750 mm, qty. in pack 22 pcs, in carton	
<b>Domino rod, Beech D 14 x 750/18 BU</b>	498689
Dimensions 14 x 750 mm, qty. in pack 18 pcs, in carton	



**Domino, Beech assortment DS 4/5/6/8/10 1060x BU** 498899  
 Domino assortment 4 x 20, 5 x 30, 6 x 40, 8 x 40, 8 x 50, 10 x 50 mm and DOMINO router for sizes 4, 5, 6, 8 and 10, dimensions 396 x 296 x 157.5 mm, qty. in pack 1,060 pcs, in SYS 2 T-LOC SYSTEMAINER

6



**DOMINO XL Beech assortment DS/XL D8/D10 306x BU** 498204  
 for DOMINO XL, domino assortment, dominos 8 x 50, 8 x 80, 8 x 100, 10 x 50, 10 x 80, 10 x 100 mm and DOMINO XL router for sizes 8 and 10, qty. in pack 306 pcs, in SYS 2 T-LOC SYSTEMAINER



**DOMINO XL Beech assortment DS/XL D12/D14 128x BU** 498205  
 for DOMINO XL, domino assortment, dominos 12 x 100, 12 x 140, 14 x 100, 14 x 140 mm and DOMINO XL router for size 14, qty. in pack 128 pcs, in SYS 2 T-LOC SYSTEMAINER

## 6.3.2 Domino and Domino rods SIPO









<b>Domino, Sipo D 5 x 30/300 MAU</b> Dimensions 5 x 30 mm, qty. in pack 300 pcs, in self-service display pack	494869
<b>Domino, Sipo D 5 x 30/900 MAU</b> Dimensions 5 x 30 mm, qty. in pack 900 pcs, in carton	494859
<b>Domino, Sipo D 6 x 40/190 MAU</b> Dimensions 6 x 40 mm, qty. in pack 190 pcs, in self-service display pack	494870
<b>Domino, Sipo D 6 x 40/570 MAU</b> Dimensions 6 x 40 mm, qty. in pack 570 pcs, in carton	494860
<b>Domino, Sipo D 8 x 40/130 MAU</b> Dimensions 8 x 40 mm, qty. in pack 130 pcs, in self-service display pack	494871
<b>Domino, Sipo D 8 x 40/390 MAU</b> Dimensions 8 x 40 mm, qty. in pack 390 pcs, in carton	494861
<b>Domino, Sipo D 8 x 50/100 MAU</b> Dimensions 8 x 50 mm, qty. in pack 100 pcs, in self-service display pack	494872
<b>Domino, Sipo D 8 x 50/300 MAU</b> Dimensions 8 x 50 mm, qty. in pack 300 pcs, in carton	494862
<b>Domino, Sipo D 10 x 50/85 MAU</b> Dimensions 10 x 50 mm, qty. in pack 85 pcs, in self-service display pack	494873
<b>Domino, Sipo D 10 x 50/255 MAU</b> Dimensions 10 x 50 mm, qty. in pack 255 pcs, in carton	494863



<b>Domino, Sipo D 8 x 750/36 MAU</b> Dimensions 8 x 750 mm, qty. in pack 36 pcs, in carton	498690
<b>Domino, Sipo D 10 x 750/28 MAU</b> Dimensions 10 x 750 mm, qty. in pack 28 pcs, in carton	498691
<b>Domino, Sipo D 12 x 750/22 MAU</b> Dimensions 12 x 750 mm, qty. in pack 22 pcs, in carton	498692
<b>Domino, Sipo D 14 x 750/18 MAU</b> Dimensions 14 x 750 mm, qty. in pack 18 pcs, in carton	498693



### 6.3.3 DOMINO corner and flat connectors

			Corner connectors	Flat connectors
	<b>Anchor bolt SV-AB D14/32</b> 32 anchor bolts for corner connections, including 64 domino connector covers for transferring transverse loads.	201350	⊙	
	<b>Expansion bolt SV-SA D14/32</b> 32 expansion bolts for secure locking.	201349	⊙	
	<b>Transverse anchor SV-QA D14/32</b> 32 transverse anchors including studs for locking anchors or double-headed bolts.	201351	⊙	
	<b>Enlarger SV-V D14/32</b> 64 domino connector covers for widening 32 transverse anchors. For widening and pressure distribution when using transverse anchors in materials such as kitchen worktops.	201498		⊙ (optional)
	<b>Double-headed bolt SV-DB D14/16</b> 16 double-headed bolts for flat connections, including 64 domino connector covers. The double-headed bolts can be clipped using 2 domino connector covers or (as shown) with 4 domino connector covers – depending on the required alignment and transverse load transmission.	201352		⊙
	<b>Connector set EV/32-Set</b> For 32 corner connectors, 32 SV-AB D14 anchor bolts, 32 SV-QA D14 transverse anchors, 32 SV-SA D14 expansion bolts.	201827	⊙	
	<b>Connector set FV/16-Set</b> For 16 flat connectors, 16 SV-DB D14 double-headed bolts, 32 SV-QA D14 transverse anchors, SV-V D14 enlargers for 32 transverse anchors.	201828		⊙

6

### 6.3.3 DOMINO corner and flat connectors

---



**Domino, birch, domino D 14 x 75/104 BU**

104 Domino, birch D 14 x 75, exactly matched to the dimensions of the corner connectors. Serves to transfer loads – in addition to the connectors.

201499



**Cover cap SV-AK D14 str/32**

32 cover caps, silver. For covering DOMINO milled holes.

201354



**Cover cap SV-AK D14 brn1/32**

32 cover caps, dark brown. For covering DOMINO milled holes.

201355



**Cover cap SV-AK D14 brn2/32**

32 cover caps, light brown. For covering DOMINO milled holes.

201356



**DOMINO connector Systainer DominoVerb Sort SV-SYS D14**

32 anchor bolts SV-AB D14, 16 double-headed bolts SV-DB D14, 128 domino connector covers for increasing transverse load transfer from the anchor bolts and double-headed bolts, 32 expansion bolts SV-SA D14, 64 transverse anchors SV-QA D14 including studs, 4 mm stud spanner for tightening studs, 64 connector covers SV-V D14 for widening 32 transverse anchors, 32 cover caps each in the colours silver, dark brown and light brown (SV-AK D14 str, SV-AK D14 brn1 and SV-AK D14 brn2), 32 dominos D14 x 75, Beech.

201353

---

Supplementary system accessories

7

---

## 7.1 Mobile dust extractors

Any Festool mobile dust extractor with an extractor hose diameter of 27 mm can be attached to the DOMINO joining machine extractor stub. The Festool system offers numerous mobile dust extractors with a wide variety of volumes, with or without automatic AUTOCLEAN cleaning technology and in different dust categories. We therefore only present a small selection of our range here. Your specialist retailer can give you all the information you need on mobile dust extractors, items included and dust categories, or go to [www.festool.com](http://www.festool.com)

---



**CT 26 | 36 | 48**

**The all-rounder.**

In three sizes to meet every need: the all-rounder for the construction site or body shop.

---



**CT 26 E AC | CT 36 E AC | CT 48 E AC**

**With dedusting.**

With automatic, infinitely variable AUTOCLEAN filter dedusting for constant extraction performance: perfect for large quantities of fine dust.

---



**CT 48 E LE EC**

**For continuous operation.**

With a durable, brushless EC-TEC drive concept: for tough continuous operation and work in quasi-stationary mode at the energy box.

---

## 7.2 MFT 3 multifunction table

When working with the DOMINO joining machines, it is extremely important that the workpieces are securely clamped and fixed to facilitate safe and precise working. To this end, the Festool system includes the MFT multifunction table, offering workpieces maximum hold thanks to flexible and reliable clamping using specially designed fixed clamps. In addition, at a working height of 90 cm, it also allows working which is easy on your back, even for taller users.



### MFT 3 multifunction table 495315

Table with perforated top and foldaway legs, swivel unit, support unit, angle stop, adjustable stop, FS 1080/2 guide rail, FS-AW deflector, additional clamp, in carton

- ▶ Extreme precision – with aluminium profile for accepting a guide rail and the angle stop
- ▶ Maximum hold – flexible and reliable clamping using specially designed fixed clamps
- ▶ Easy on your back – the 90 cm working height is pleasant for taller users
- ▶ Ideal for mobile use – the MFT 3 can be easily folded away

### Specifications

Table dimensions (mm)	1,157 x 773
Table height, legs folded away (mm)	180
Table height, legs unfolded (mm)	900
Max. workpiece thickness (mm)	78
Max. workpiece width (mm)	700
Load capacity (kg)	120
Weight (kg)	28

## MFT 3 Accessories



**MFT 3-QT cross brace** 495502  
for additional stabilisation of the MFT 3, qty. in pack 2 pcs, diameter 20 mm, length 675 mm, in carton



**MFT-SP fixed clamps** 488030  
for reliable and exact workpiece fixing (sawing, sanding, routing, drilling, etc.), qty. in pack 2 pcs, in self-service display pack



**FSZ 120 fastening clamp** 489570  
All-steel design, clamping width 120 mm, qty. in pack 2 pcs, in self-service display pack



**FSZ 300 fastening clamp** 489571  
All-steel design, clamping width 300 mm, qty. in pack 2 pcs, in self-service display pack



**FS-HZ 160 lever clamp** 491594  
All-steel design, clamping width 160 mm, in self-service display pack



**VS connecting piece** 484455  
for connecting the FST 660/85 or MFT 800 to Basis Plus, for connecting several MFT 3, in self-service display pack



**VAC SYS AD MFT 3 adapter** 494977  
for VAC SYS SE 1, VAC SYS SE 2, for connecting the VAC SYS clamping unit with the MFT 3, in carton

## 7.3 VAC SYS vacuum pump and clamping unit

The VAC SYS vacuum clamping system provides even more clamping options and the possibility of working from all sides, in addition to the MFT. It allows workpieces to be rotated through 360° and swivelled through 90°. The clamping pads are of soft and flexible plastic and are therefore also suitable for sensitive surfaces. Workpieces up to 30 kg and 1 x 1 m can be clamped per clamping unit.



**VAC SYS Set SE 1** 712223

VAC SYS VP vacuum pump in the SYS 3 SYSTAINER, VAC SYS SE 1 vacuum clamping unit with VAC SYS VT D 215 mm vacuum pad, vacuum hose and foot valve in SYS 4 SYSTAINER

**VAC SYS SE 2** 580062

VAC SYS VT 275 x 100 mm vacuum pad, connecting piece, vacuum hose, in SYS 4 SYSTAINER

### Specifications

Power consumption at 50 Hz (W)	160 – 200
Power consumption at 60 Hz (W)	200 – 230
Pump capacity at 50 Hz (m <sup>3</sup> /h)	2.7
Pump capacity at 60 Hz (m <sup>3</sup> /h)	3.5
Minimum vacuum (mbar)	≥ 81% / ≥ 810
Weight (kg)	8

## VAC SYS Accessories



**VAC SYS VT 200 x 60 vacuum pad** 580064

for VAC SYS SE 1, VAC SYS SE 2, pad dimensions 200 x 60 mm, in carton



**VAC SYS VT 275 x 100 vacuum pad** 580066

for VAC SYS SE 1, VAC SYS SE 2, pad dimensions 275 x 100 mm, in carton



**VAC SYS VT 277 x 32 vacuum pad** 580065

for VAC SYS SE 1, VAC SYS SE 2, pad dimensions 277 x 32 mm, in carton



**VAC SYS VT D 215 vacuum pad** 580067

for VAC SYS SE 1, VAC SYS SE 2, diameter 215 mm, in carton



**VAC SYS AD MFT 3 adapter** 494977

for VAC SYS SE 1, VAC SYS SE 2, for connecting the VAC SYS clamping unit with the MFT 3, in carton



**VAC SYS VT Sort accessories SYSTAINER** 495294

VAC SYS VT 200 x 60, VAC SYS VT 277 x 32, VAC SYS VT 275 x 100, also provides space for VAC SYS VT D 215, in SYS 3 SYSTAINER

# CONCENTRATE ON WHAT'S MOST IMPORTANT: YOUR WORK.

Every day we consider how we can make life easier for you. With highly sophisticated tools and services which are tailored to the demands of your work. You want to and need to avoid downtime, unnecessary expenses and additional costs as much as possible. We understand that, which is why we're doing our bit to help you with our SERVICE all-inclusive.

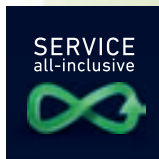

For more information about SERVICE all-inclusive, its validity and our service terms and conditions, please visit [www.festool.com/service](http://www.festool.com/service)

Register online up to 30 days after purchase to benefit from all services!

[www.festool.com/service](http://www.festool.com/service)

#### **3-year guarantee.**

Register each individual machine to receive even more service benefits and extend the guarantee on your machine to 3 years.

#### **Repair service.**

Our SERVICE all-inclusive package guarantees professional repairs and ensures your machine is ready to use again in no time.

#### **10 years of spare parts availability.**

We promise to stock spare parts for your machine for a minimum of 10 years. If not, we will send you a new replacement machine completely free of charge.

#### **Application consultancy.**

We provide you with advice whenever you need it. Contact us!

---

## Notes

---

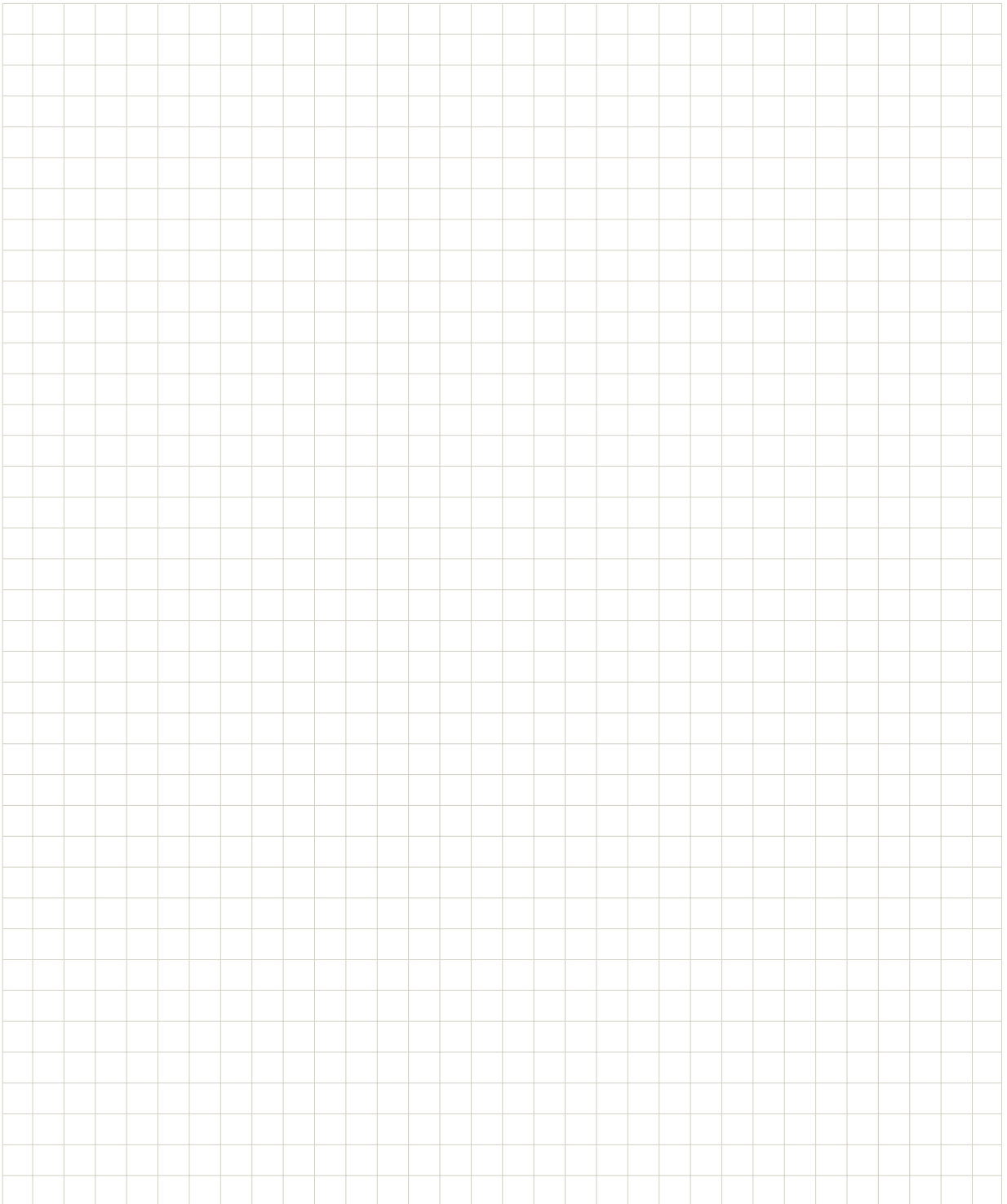









# FESTOOL

Tools for the toughest demands

## **Festool GmbH**

### **Export Department**

Wertstrasse 20

D-73240 Wendlingen

Phone +49 (0)70 24/804-20640

Fax +49 (0)70 24/804-20724

E-mail [Roland.Eiberger@festool.com](mailto:Roland.Eiberger@festool.com)

## **UAB „TTS Tooltechnic Systems“**

Ašigalio g. 6

LT-49142 Kaunas

Lietuva

Phone: +370 37 308 414

Fax: +370 37 323848

E-mail: [info@tts-company.lt](mailto:info@tts-company.lt)

[www.festool.com](http://www.festool.com)

**Festool**

**DOMINO system user manual**

Order no. 65697 IMP-LT/en



4 014549 271414

Subject to changes and errors. All images are non-binding.  
Produced for Festool GmbH, 73240 Wendlingen, Germany,  
01/2016

Vibration levels and emission values can be found in the  
operating instructions at [www.festool.com/vibration](http://www.festool.com/vibration)